

## Features

- Glass Passivated Die Construction
- Ideally Suited for Automatic Assembly
- Super-Fast Recovery Time
- High Voltage Capability
- Low Power Loss, High Efficiency
- High Surge Current Capability
- For Use in High Voltage, High Frequency Inverters, Free Wheeling, and Switching Power Supplies

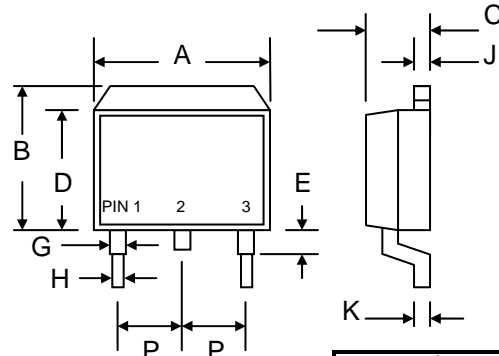

## Mechanical Data

- Case: D<sup>2</sup>PAK/TO-263, Molded Plastic
- Terminals: Plated Leads Solderable per MIL-STD-202, Method 208
- Polarity: See Diagram
- Weight: 1.7 grams (approx.)
- Mounting Position: Any
- Marking: Device Code, See Page 3
- **Lead Free: For RoHS / Lead Free Version, Add "-LF" Suffix to Part Number, See Page 4**

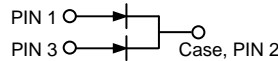

D <sup>2</sup> PAK/TO-263		
Dim	Min	Max
A	9.80	10.40
B	9.60	10.60
C	4.40	4.80
D	8.50	9.10
E	—	2.80
G	1.00	1.40
H	—	0.99
J	1.20	1.40
K	0.30	0.70
P	2.35	2.75
All Dimensions in mm		

## Maximum Ratings and Electrical Characteristics @T<sub>A</sub>=25°C unless otherwise specified

Single Phase, half wave, 60Hz, resistive or inductive load. For capacitive load, derate current by 20%.

Characteristic	Symbol	MURB 1020CT	MURB 1030CT	MURB 1040CT	MURB 1060CT	Unit
Peak Repetitive Reverse Voltage Working Peak Reverse Voltage DC Blocking Voltage	V <sub>RRM</sub> V <sub>RWM</sub> V <sub>R</sub>	200	300	400	600	V
RMS Reverse Voltage	V <sub>R(RMS)</sub>	140	210	280	420	V
Average Rectified Output Current @T <sub>C</sub> = 100°C	Total Device Per Diode I <sub>O</sub>	10 5.0				A
Non-Repetitive Peak Forward Surge Current 8.3ms Single Half Sine-Wave Superimposed on Rated Load (JEDEC Method)	I <sub>FSM</sub>	150				A
Forward Voltage per diode @I <sub>F</sub> = 5.0A	V <sub>FM</sub>	0.95	1.3	1.7	V	
Peak Reverse Current At Rated DC Blocking Voltage	@T <sub>C</sub> = 25°C @T <sub>C</sub> = 100°C I <sub>RM</sub>	10 500				μA
Reverse Recovery Time (Note 1)	t <sub>rr</sub>	35	50		nS	
Typical Junction Capacitance (Note 2)	C <sub>J</sub>	70	50		pF	
Thermal Resistance Junction to Ambient per diode Thermal Resistance Junction to Case per diode	R <sub>JA</sub> R <sub>JC</sub>	60 3.0				°C/W
Operating and Storage Temperature Range	T <sub>J</sub> , T <sub>STG</sub>	-55 to +150				°C

Note: 1. Measured with I<sub>F</sub> = 0.5A, I<sub>R</sub> = 1.0A, I<sub>RR</sub> = 0.25A.  
2. Measured at 1.0 MHz and applied reverse voltage of 4.0V D.C.

# MURB1020CT – MURB1060CT

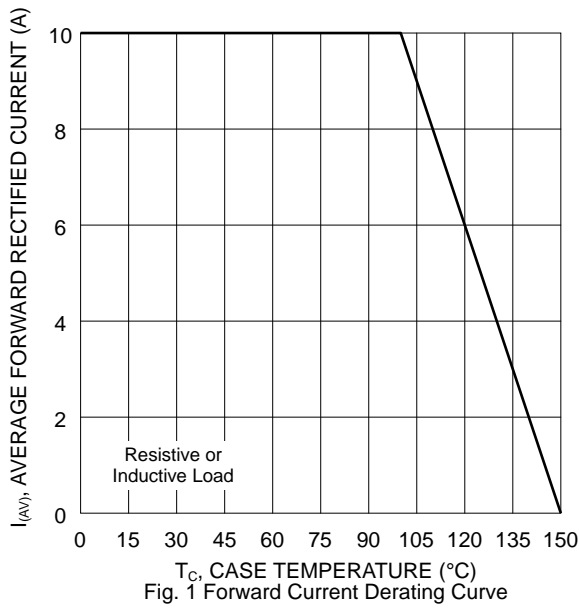

Fig. 1 Forward Current Derating Curve

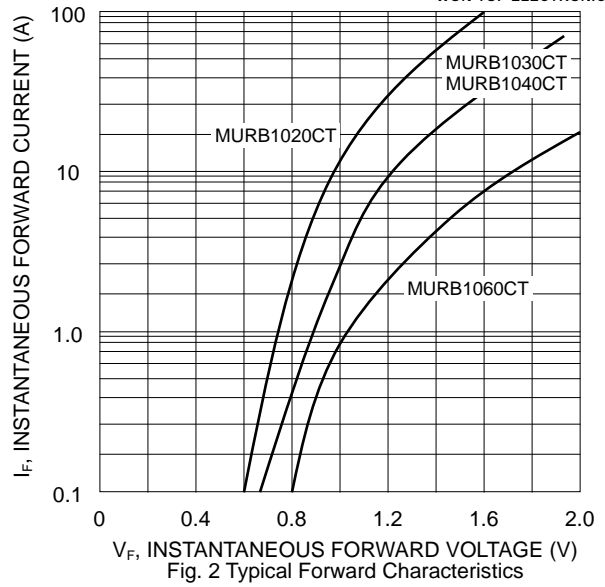

Fig. 2 Typical Forward Characteristics

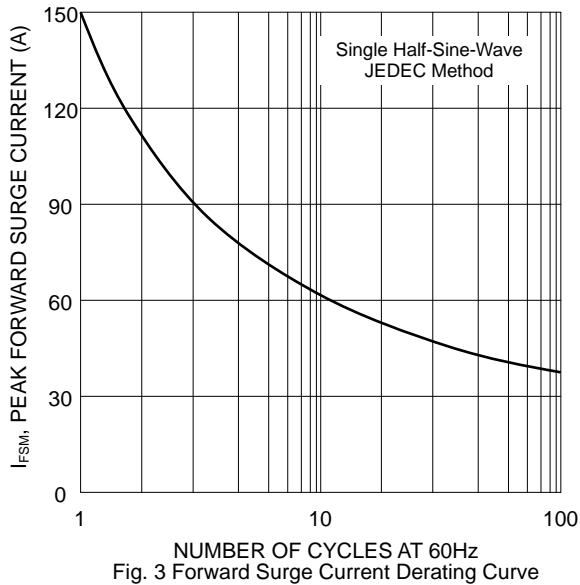

Fig. 3 Forward Surge Current Derating Curve

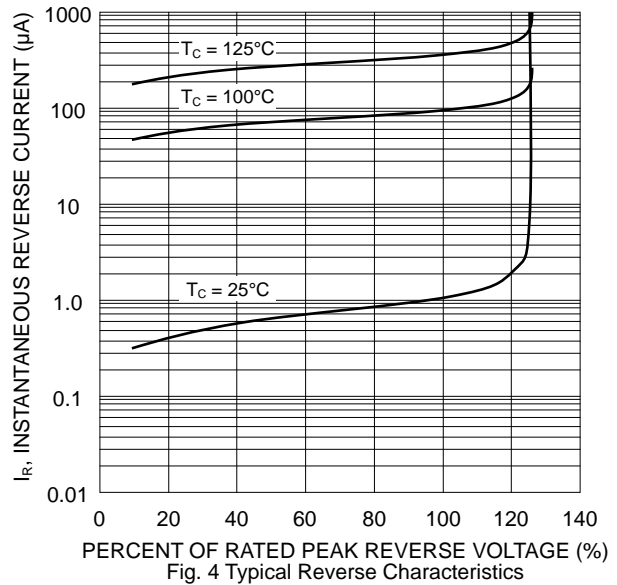

Fig. 4 Typical Reverse Characteristics

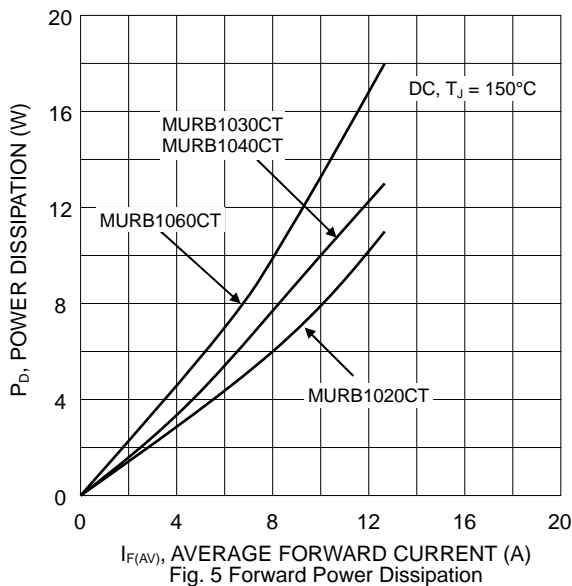

Fig. 5 Forward Power Dissipation

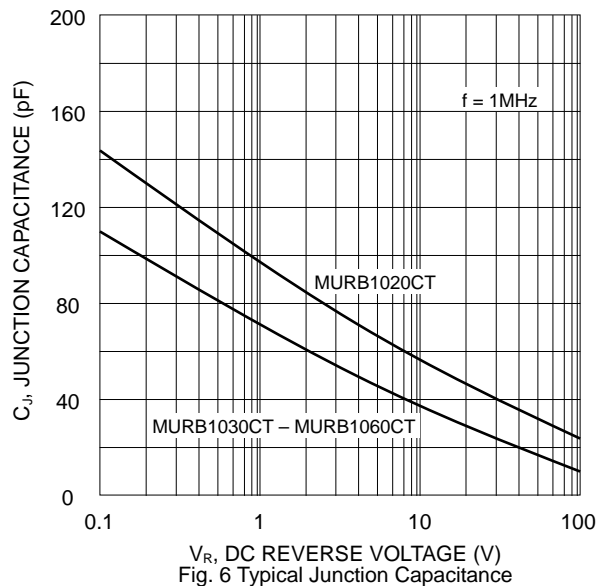
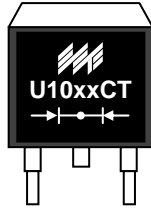

Fig. 6 Typical Junction Capacitance

## MARKING INFORMATION



U10xxCT = Device Number  
 xx = 20 (MURB1020CT)  
       30 (MURB1030CT)  
       40 (MURB1040CT)  
       60 (MURB1060CT)  
 Polarity = As Marked on Body

## RECOMMENDED FOOTPRINT

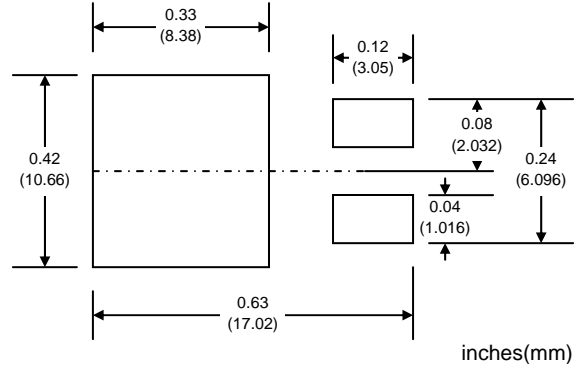

## PACKAGING INFORMATION

### TAPE & REEL

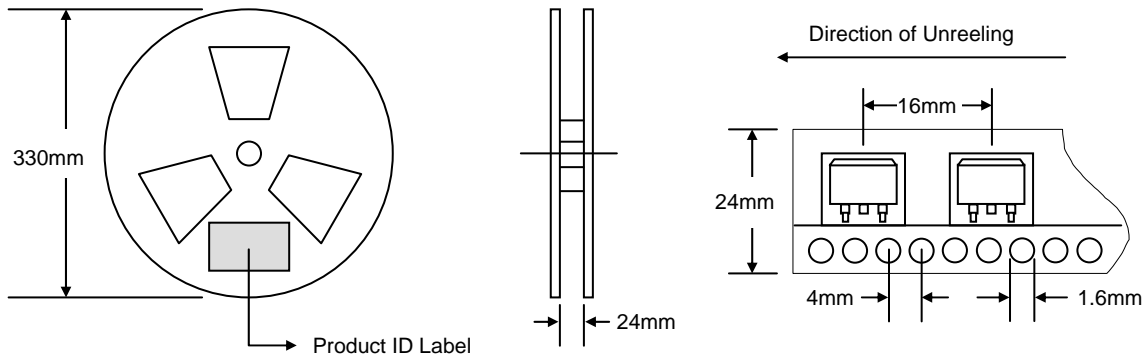

Reel Diameter (mm)	Quantity (PCS)	Inner Box Size L x W x H (mm)	Quantity (PCS)	Carton Size L x W x H (mm)	Quantity (PCS)	Approx. Gross Weight (KG)
330	800	340 x 337 x 45	800	370 x 370 x 420	6,400	15.0

**Note:** 1. Paper reel, white or gray color.  
 2. Components are packed in accordance with EIA standard 481-1 and 481-2.

## ORDERING INFORMATION

Product No.	Package Type	Shipping Quantity
MURB1020CT-T3	D <sup>2</sup> PAK	800/Tape & Reel
MURB1030CT-T3	D <sup>2</sup> PAK	800/Tape & Reel
MURB1040CT-T3	D <sup>2</sup> PAK	800/Tape & Reel
MURB1060CT-T3	D <sup>2</sup> PAK	800/Tape & Reel

1. Shipping quantity given is for minimum packing quantity only. For minimum order quantity, please consult the Sales Department.
2. **To order RoHS / Lead Free version (with Lead Free finish), add "-LF" suffix to part number above. For example, MURB1020CT-T3-LF.**

WON-TOP ELECTRONICS and  are registered trademarks of Won-Top Electronics Co., Ltd (WTE). WTE has checked all information carefully and believes it to be correct and accurate. However, WTE cannot assume any responsibility for inaccuracies. Furthermore, this information does not give the purchaser of semiconductor devices any license under patent rights to manufacturer. WTE reserves the right to change any or all information herein without further notice.

**WARNING:** DO NOT USE IN LIFE SUPPORT EQUIPMENT. WTE power semiconductor products are not authorized for use as critical components in life support devices or systems without the express written approval.

**Won-Top Electronics Co., Ltd.**  
No. 44 Yu Kang North 3rd Road,  
Chine Chen Dist., Kaohsiung 806, Taiwan  
**Phone:** 886-7-822-5408 or 886-7-822-5410  
**Fax:** 886-7-822-5417  
**Email:** sales@wontop.com  
**Internet:** http://www.wontop.com

*We power your everyday.*