

Features

- Glass Passivated Die Construction
- Low Forward Voltage Drop
- High Current Capability
- High Reliability
- High Surge Current Capability
- Ideal for Printed Circuit Boards
-  Recognized File # E157705

Mechanical Data

- Case: GBJ-6, Molded Plastic
- Terminals: Plated Leads Solderable per MIL-STD-202, Method 208
- Polarity: As Marked on Body
- Weight: 7.0 grams (approx.)
- Mounting Position: Any
- Mounting Torque: 0.8 N.m Max.
- **Lead Free: For RoHS / Lead Free Version, Add "-LF" Suffix to Part Number, See Page 4**

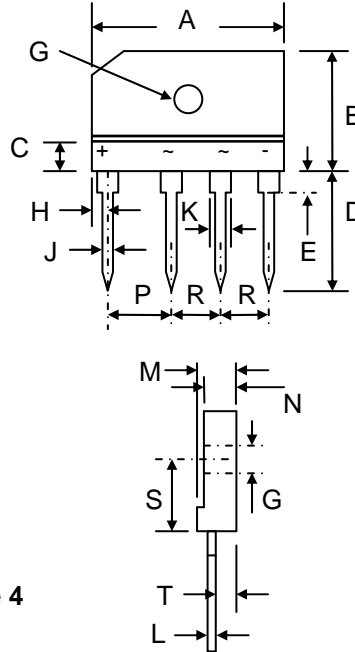

GBJ-6		
Dim	Min	Max
A	29.7	30.3
B	19.7	20.3
C	4.8	5.8
D	17.0	18.0
E	3.6	4.2
G	3.1Ø	3.4Ø
H	2.3	2.7
J	0.9	1.1
K	2.0	2.4
L	0.6	0.8
M	4.4	4.8
N	3.4	3.8
P	9.8	10.2
R	7.3	7.7
S	10.8	11.2
T	2.5	2.9
All Dimensions in mm		

Maximum Ratings and Electrical Characteristics @ $T_A=25^\circ\text{C}$ unless otherwise specified

Single Phase, half wave, 60Hz, resistive or inductive load. For capacitive load, derate current by 20%.

Characteristic	Symbol	GBJ 15A	GBJ 15B	GBJ 15D	GBJ 15G	GBJ 15J	GBJ 15K	GBJ 15M	GBJ 15Q	Unit
Peak Repetitive Reverse Voltage	V_{RRM}									
Working Peak Reverse Voltage	V_{RWM}	50	100	200	400	600	800	1000	1200	V
DC Blocking Voltage	V_R									
RMS Reverse Voltage	$V_{R(RMS)}$	35	70	140	280	420	560	700	840	V
Average Rectified Output Current @ $T_C = 100^\circ\text{C}$ (Note 1)	I_o	15								A
Non-Repetitive Peak Forward Surge Current 8.3ms Single Half Sine-Wave Superimposed on Rated Load (JEDEC Method)	I_{FSM}	240								A
Forward Voltage per leg @ $I_F = 7.5\text{A}$	V_{FM}	1.05								V
Peak Reverse Current @ $T_A = 25^\circ\text{C}$ At Rated DC Blocking Voltage @ $T_A = 125^\circ\text{C}$	I_{RM}	10 500								μA
I^2t Rating for Fusing ($t < 8.3\text{ms}$)	I^2t	200								A^2s
Typical Junction Capacitance (Note 2)	C_J	70								pF
Thermal Resistance Junction to Ambient (Note 3)	R_{JA}	22								$^\circ\text{C}/\text{W}$
Thermal Resistance Junction to Case (Note 1)	R_{JC}	1.5								
RMS Isolation Voltage Terminals to Case, $t = 1\text{min}$	V_{ISO}	2500								V
Operating and Storage Temperature Range	T_J, T_{STG}	-55 to +150								$^\circ\text{C}$

Note: 1. Mounted on 300 x 300 x 1.6mm thick Al. heatsink.
 2. Measured at 1.0 MHz and applied reverse voltage of 4.0V D.C.
 3. Mounted on PCB with 12 x 12mm copper pads and measured at lead length 9.5mm from case.

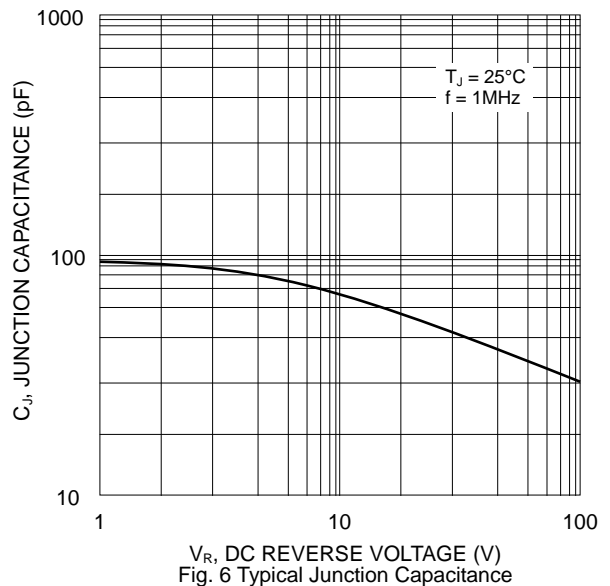
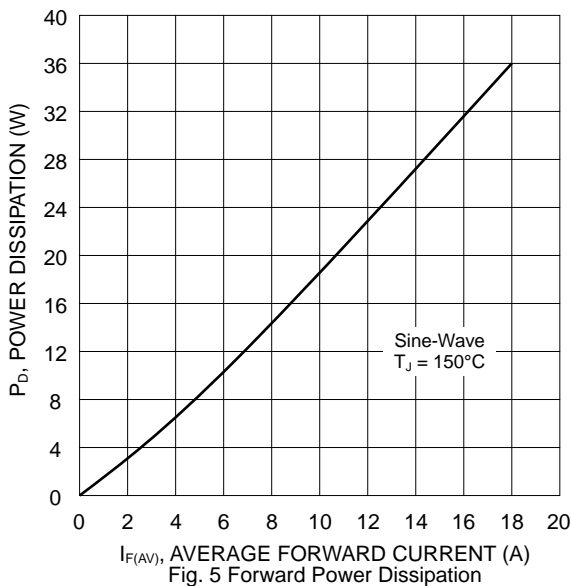
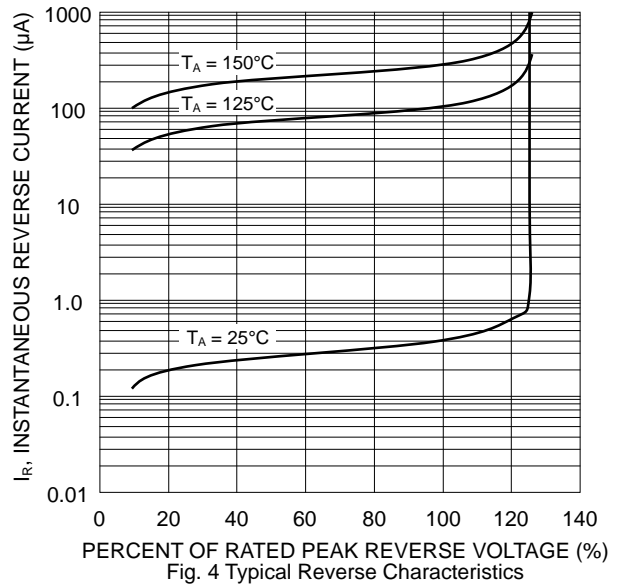
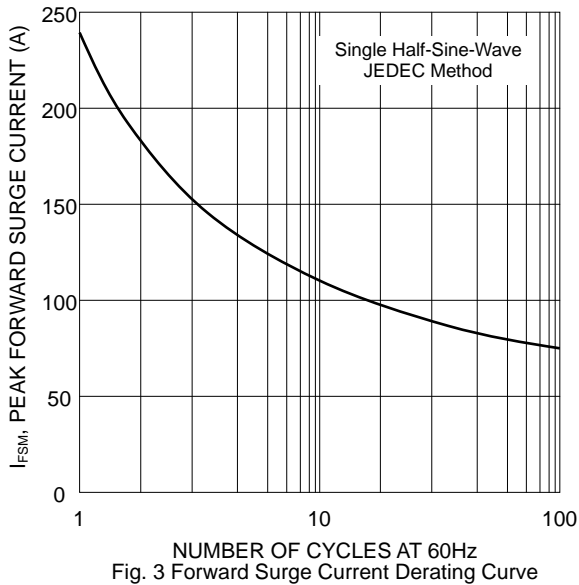
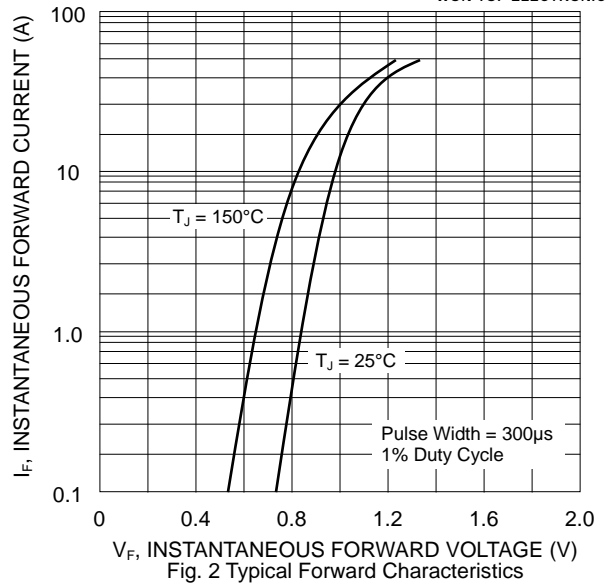
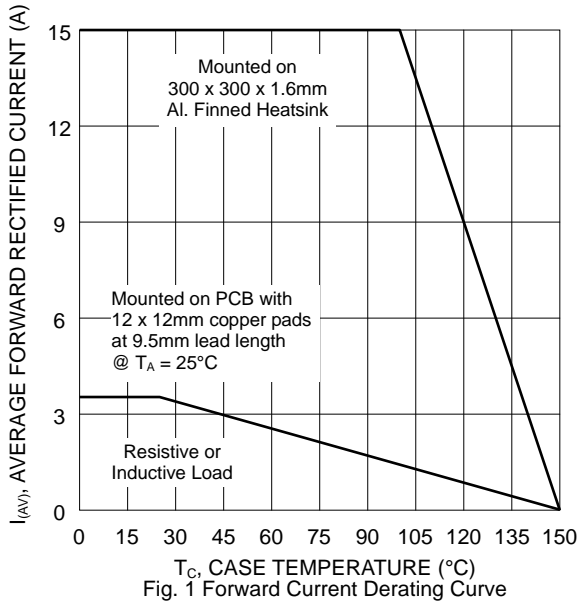

MARKING INFORMATION

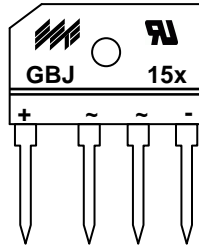

GBJ15x = Device Number
 x = A, B, D, G, J, K, M or Q
 Polarity = As Marked on Body

PACKAGING INFORMATION

BULK

Tube Size L x W x H (mm)	Quantity (PCS)	Inner Box Size L x W x H (mm)	Quantity (PCS)	Carton Size L x W x H (mm)	Quantity (PCS)	Approx. Gross Weight (KG)
475 x 40 x 7	15	490 x 145 x 135	750	510 x 305 x 160	1,500	16.0

Note: 1. Anti-static tube, water clear color.

ORDERING INFORMATION

Product No.	Package Type	Shipping Quantity
GBJ15A	SIL Bridge	15 Units/Tube
GBJ15B	SIL Bridge	15 Units/Tube
GBJ15D	SIL Bridge	15 Units/Tube
GBJ15G	SIL Bridge	15 Units/Tube
GBJ15J	SIL Bridge	15 Units/Tube
GBJ15K	SIL Bridge	15 Units/Tube
GBJ15M	SIL Bridge	15 Units/Tube
GBJ15Q	SIL Bridge	15 Units/Tube

1. Shipping quantity given is for minimum packing quantity only. For minimum order quantity, please consult the Sales Department.
2. **To order RoHS / Lead Free version (with Lead Free finish), add "-LF" suffix to part number above. For example, GBJ15A-LF.**

WON-TOP ELECTRONICS and  are registered trademarks of Won-Top Electronics Co., Ltd (WTE). WTE has checked all information carefully and believes it to be correct and accurate. However, WTE cannot assume any responsibility for inaccuracies. Furthermore, this information does not give the purchaser of semiconductor devices any license under patent rights to manufacturer. WTE reserves the right to change any or all information herein without further notice.

WARNING: DO NOT USE IN LIFE SUPPORT EQUIPMENT. WTE power semiconductor products are not authorized for use as critical components in life support devices or systems without the express written approval.

Won-Top Electronics Co., Ltd.
No. 44 Yu Kang North 3rd Road,
Chine Chen Dist., Kaohsiung 806, Taiwan
Phone: 886-7-822-5408 or 886-7-822-5410
Fax: 886-7-822-5417
Email: sales@wontop.com
Internet: <http://www.wontop.com>

We power your everyday.