

### Features

- Glass Passivated Die Construction
- Ultra-Fast Switching
- Low Forward Voltage Drop
- Low Reverse Leakage Current
- High Surge Current Capability
- Plastic Material has UL Flammability Classification 94V-O

### Mechanical Data

- Case: ITO-220, Full Molded Plastic
- Terminals: Plated Leads Solderable per MIL-STD-202, Method 208
- Polarity: See Diagram
- Weight: 2.24 grams (approx.)
- Mounting Position: Any
- Mounting Torque: 11.5 cm·kg (10 in·lbs) Max.
- **Lead Free: For RoHS / Lead Free Version, Add “-LF” Suffix to Part Number, See Page 4**

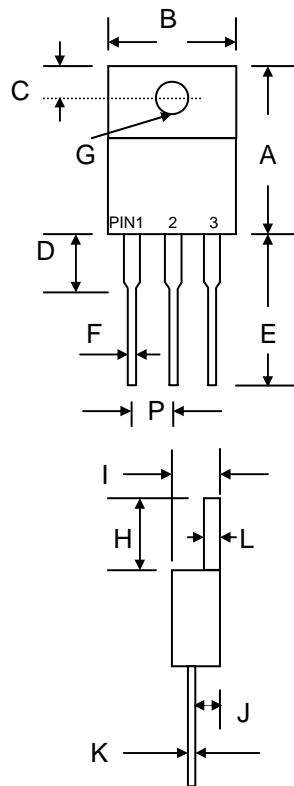

ITO-220		
Dim	Min	Max
A	14.60	15.40
B	9.70	10.30
C	2.55	2.85
D	2.70	3.30
E	13.00	13.80
F	0.50	0.75
G	3.00 Ø	3.50 Ø
H	6.30	6.90
I	4.20	4.80
J	2.50	2.90
K	0.50	0.75
L	2.70	3.15
P	2.29	2.79
All Dimensions in mm		

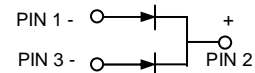

### Maximum Ratings and Electrical Characteristics @ $T_A=25^\circ\text{C}$ unless otherwise specified

Single Phase, half wave, 60Hz, resistive or inductive load.  
 For capacitive load, derate current by 20%.

Characteristic	Symbol	UF	UF	UF	UF	UF	UF	UF	Unit
		1600FCT	1601FCT	1602FCT	1603FCT	1604FCT	1606FCT	1608FCT	
Peak Repetitive Reverse Voltage	$V_{RRM}$								V
Working Peak Reverse Voltage	$V_{RWM}$	50	100	200	300	400	600	800	
DC Blocking Voltage	$V_R$								
RMS Reverse Voltage	$V_{R(RMS)}$	35	70	140	210	280	420	560	V
Average Rectified Output Current @ $T_C = 105^\circ\text{C}$	$I_o$	16							A
Non-Repetitive Peak Forward Surge Current 8.3ms Single half sine-wave superimposed on rated load (JEDEC Method)	$I_{FSM}$	125							A
Forward Voltage @ $I_F = 8.0\text{A}$	$V_{FM}$	1.0			1.3		1.7		V
Peak Reverse Current @ $T_A = 25^\circ\text{C}$ At Rated DC Blocking Voltage @ $T_A = 125^\circ\text{C}$	$I_{RM}$	10 500							$\mu\text{A}$
Reverse Recovery Time (Note 1)	$t_{rr}$	50					100		nS
Typical Junction Capacitance (Note 2)	$C_j$	80					50		pF
Operating and Storage Temperature Range	$T_j, T_{STG}$	-65 to +150							$^\circ\text{C}$

Note: 1. Measured with  $I_F = 0.5\text{A}$ ,  $I_R = 1.0\text{A}$ ,  $IRR = 0.25\text{A}$ .  
 2. Measured at 1.0 MHz and applied reverse voltage of 4.0V D.C.

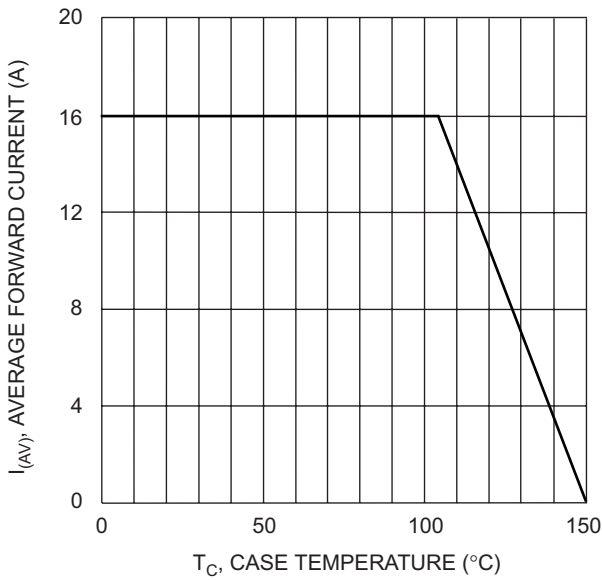

Fig. 1 Forward Current Derating Curve

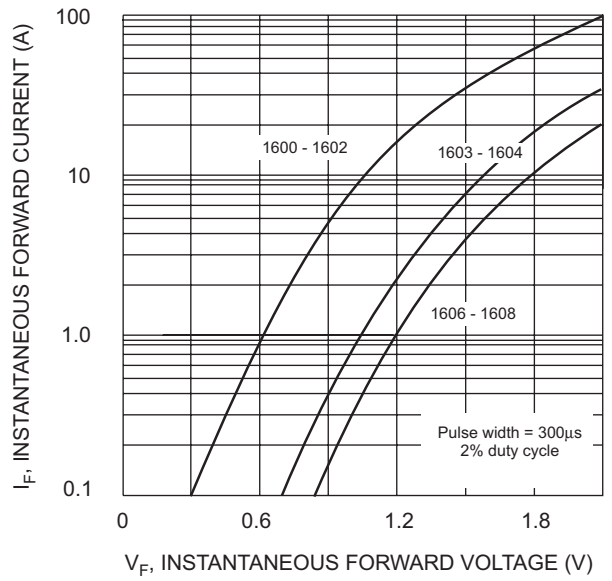

Fig. 2 Typical Forward Characteristics

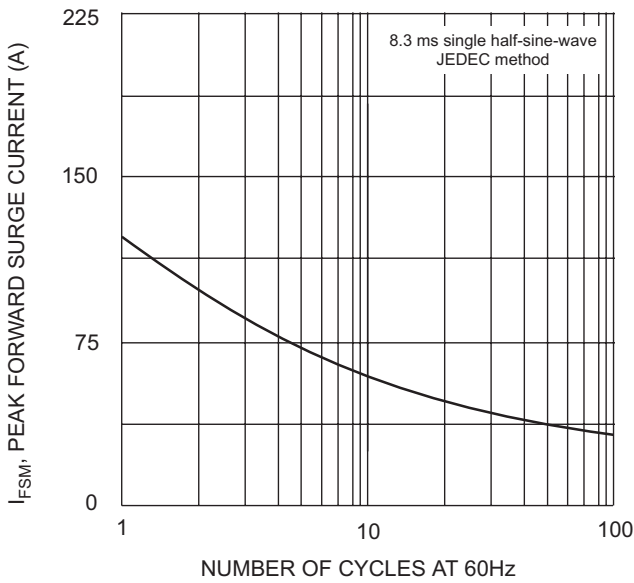

Fig. 3 Maximum Non-Repetitive Surge Current

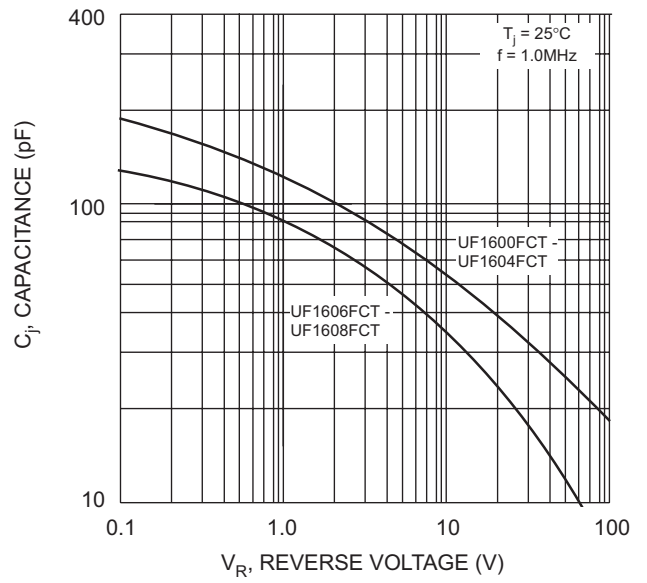
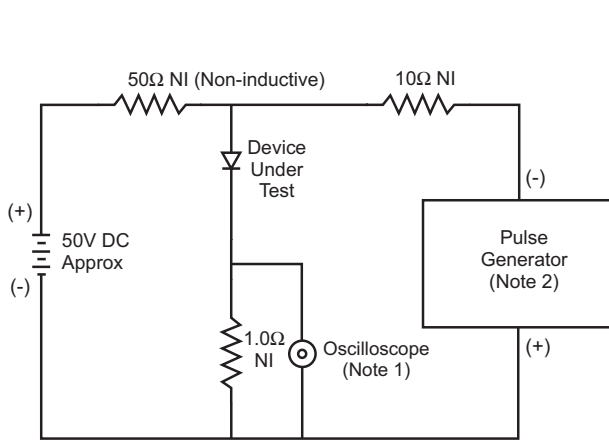

Fig. 4 Typical Junction Capacitance



- Notes:
1. Rise Time = 7.0ns max. Input Impedance = 1.0MΩ, 22pF.
  2. Rise Time = 10ns max. Input Impedance = 50Ω.

Set time base for 5/10ns/cm

Fig. 5 Reverse Recovery Time Characteristic and Test Circuit

## MARKING INFORMATION

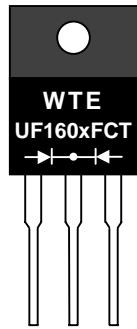

WTE = Manufacturer's Logo  
 UF160xFCT = Device Number  
 x = 0, 1, 2, 3, 4, 6 or 8  
 Polarity = As Marked on Body

## PACKAGING INFORMATION

### BULK

Tube Size L x W x H (mm)	Quantity (PCS)	Inner Box Size L x W x H (mm)	Quantity (PCS)	Carton Size L x W x H (mm)	Quantity (PCS)	Approx. Gross Weight (KG)
525 x 31 x 6	50	555 x 145 x 95	2,000	572 x 306 x 218	8,000	19.0

**Note:** 1. Anti-static tube, water clear color.

## RECOMMENDED SCREW MOUNTING ARRANGEMENT

The full molded plastic package affords a major reduction of hardware as compared to a standard TO-220 package. However, precautions should be made in mounting procedure.

A conical washer should be used to apply proper force to the device. Screw should not be tightened with any type of air-forced torque or equipment that may cause crack on device package.

A layer of thermal grease or thermal pad in the interface will be considerably helpful for heat dissipation.

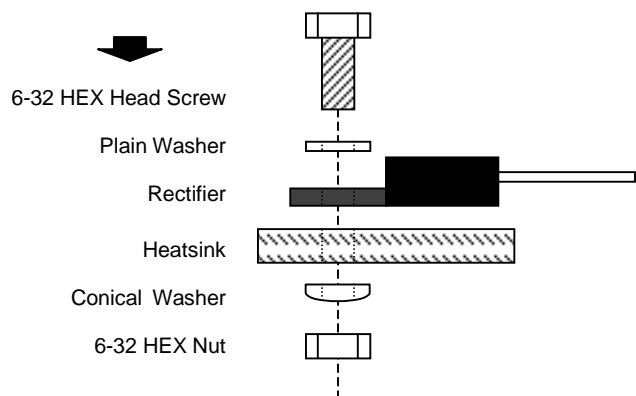

## ORDERING INFORMATION

Product No.	Package Type	Shipping Quantity
UF1600FCT	ITO-220	50 Units/Tube
UF1601FCT	ITO-220	50 Units/Tube
UF1602FCT	ITO-220	50 Units/Tube
UF1603FCT	ITO-220	50 Units/Tube
UF1604FCT	ITO-220	50 Units/Tube
UF1606FCT	ITO-220	50 Units/Tube
UF1608FCT	ITO-220	50 Units/Tube

1. Shipping quantity given is for minimum packing quantity only. For minimum order quantity, please consult the Sales Department.
2. **To order RoHS / Lead Free version (with Lead Free finish), add "-LF" suffix to part number above. For example, UF1600FCT-LF.**

Won-Top Electronics Co., Ltd (WTE) has checked all information carefully and believes it to be correct and accurate. However, WTE cannot assume any responsibility for inaccuracies. Furthermore, this information does not give the purchaser of semiconductor devices any license under patent rights to manufacturer. WTE reserves the right to change any or all information herein without further notice.

**WARNING:** DO NOT USE IN LIFE SUPPORT EQUIPMENT. WTE power semiconductor products are not authorized for use as critical components in life support devices or systems without the express written approval.

**Won-Top Electronics Co., Ltd.**

No. 44 Yu Kang North 3rd Road, Chine Chen Dist., Kaohsiung, Taiwan

**Phone:** 886-7-822-5408 or 886-7-822-5410

**Fax:** 886-7-822-5417

**Email:** sales@wontop.com

**Internet:** <http://www.wontop.com>

*We power your everyday.*