

30A GLASS PASSIVATED DUAL SUPERFAST RECTIFIER

Features

- Glass Passivated Die Construction
- Super-Fast Switching
- Low Forward Voltage Drop
- Low Reverse Leakage Current
- High Surge Current Capability
- Plastic Material has UL Flammability Classification 94V-O

Mechanical Data

- Case: TO-3P, Molded Plastic
- Terminals: Plated Leads Solderable per MIL-STD-750, Method 2026
- Polarity: See Diagram
- Weight: 5.6 grams (approx.)
- Mounting Position: Any
- Mounting Torque: 11.5 cm·kg (10 in·lbs) Max.
- **Lead Free: For RoHS / Lead Free Version, Add "-LF" Suffix to Part Number, See Page 4**

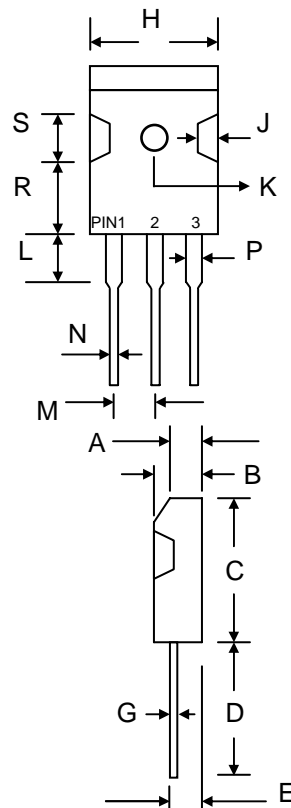

TO-3P		
Dim	Min	Max
A	3.20	3.50
B	4.70	5.30
C	—	23.00
D	19.00	—
E	2.80	3.20
G	0.45	0.85
H	—	16.20
J	1.70	2.70
K	3.15 Ø	3.65 Ø
L	—	4.50
M	5.25	5.65
N	1.10	1.40
P	—	2.50
R	11.70	12.70
S	5.00	6.00
All Dimensions in mm		

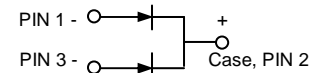

Maximum Ratings and Electrical Characteristics @T_A=25°C unless otherwise specified

Single Phase, half wave, 60Hz, resistive or inductive load.
For capacitive load, derate current by 20%.

Characteristic	Symbol	U30D 05C	U30D 10C	U30D 15C	U30D 20C	U30D 30C	U30D 40C	U30D 50C	U30D 60C	Unit
Peak Repetitive Reverse Voltage Working Peak Reverse Voltage DC Blocking Voltage	V _{RRM} V _{VRWM} V _R	50	100	150	200	300	400	500	600	V
RMS Reverse Voltage	V _{R(RMS)}	35	70	105	140	210	280	350	420	V
Average Rectified Output Current @T _C = 100°C	I _O	30								A
Non-Repetitive Peak Forward Surge Current 8.3ms Single half sine-wave superimposed on rated load (JEDEC Method)	I _{FSM}	300								A
Forward Voltage @I _F = 15A	V _{FM}	0.975			1.3		1.7			V
Peak Reverse Current @T _A = 25°C At Rated DC Blocking Voltage @T _A = 100°C	I _{RM}					10 500				µA
Reverse Recovery Time (Note 1)	t _{rr}	35			50				nS	
Typical Junction Capacitance (Note 2)	C _j	150						120		pF
Operating and Storage Temperature Range	T _J , T _{STG}	-55 to +150								°C

Note: 1. Measured with I_F = 0.5A, I_R = 1.0A, I_{RR} = 0.25A. See figure 5.
2. Measured at 1.0 MHz and applied reverse voltage of 4.0V D.C.

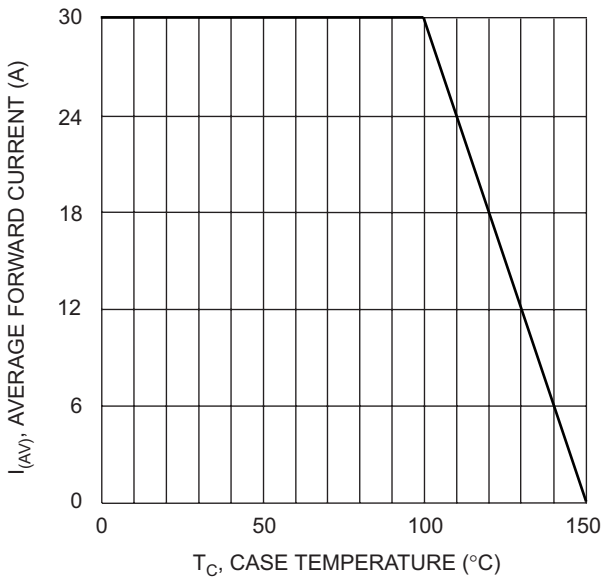

Fig. 1 Forward Current Derating Curve

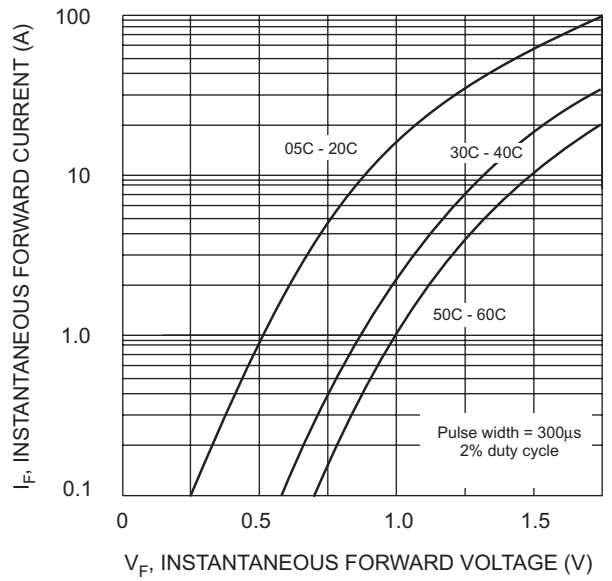

Fig. 2 Typical Forward Characteristics

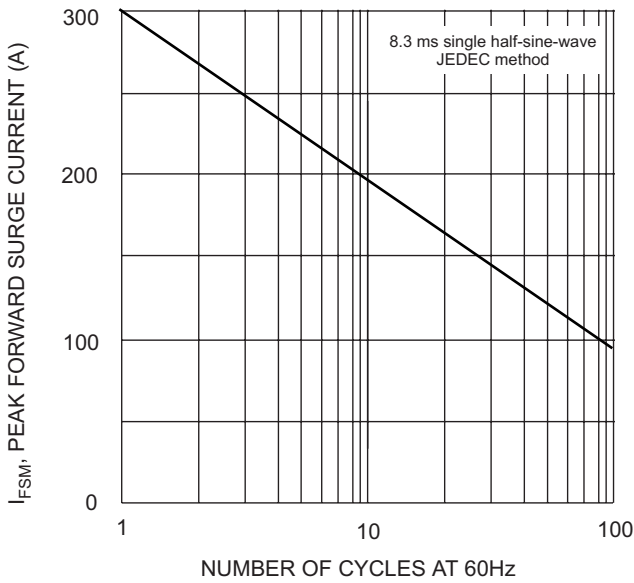

Fig. 3 Maximum Non-Repetitive Surge Current

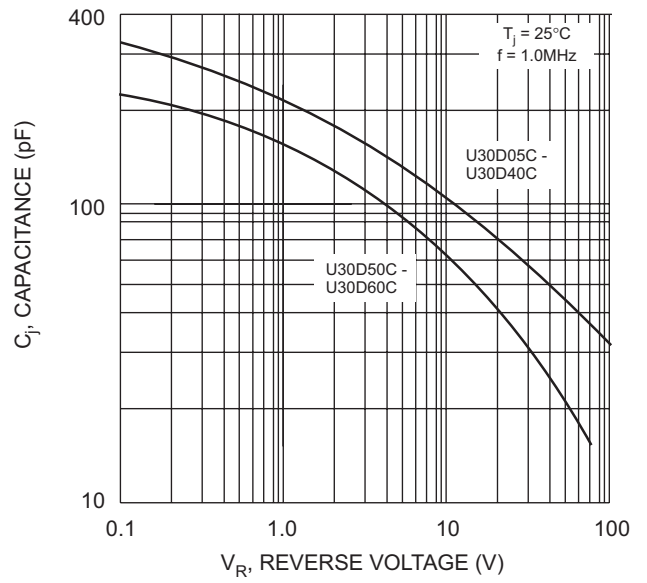
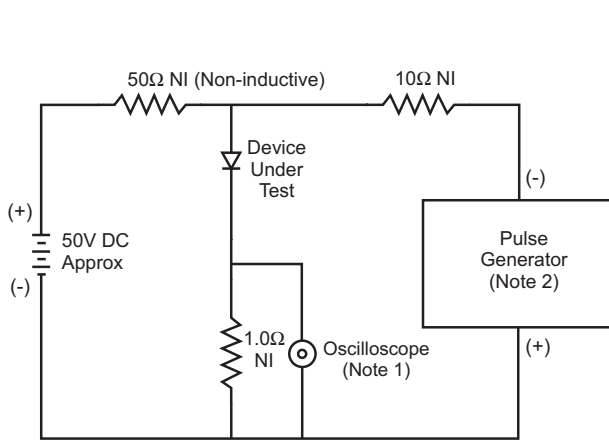

Fig. 4 Typical Junction Capacitance



- Notes:
1. Rise Time = 7.0ns max. Input Impedance = 1.0MΩ, 22pF.
 2. Rise Time = 10ns max. Input Impedance = 50Ω.

Set time base for 5/10ns/cm

Fig. 5 Reverse Recovery Time Characteristic and Test Circuit

MARKING INFORMATION

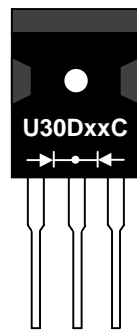

U30DxxC = Device Number
 xx = 05, 10, 15, 20, 30, 40, 50 or 60
 Polarity = As Marked on Body

PACKAGING INFORMATION

BULK

Tube Size L x W x H (mm)	Quantity (PCS)	Inner Box Size L x W x H (mm)	Quantity (PCS)	Carton Size L x W x H (mm)	Quantity (PCS)	Approx. Gross Weight (KG)
505 x 46 x 6.5	30	520 x 145 x 95	1,200	540 x 306 x 115	2,400	18.0

Note: 1. Anti-static tube, water clear color.

RECOMMENDED SCREW MOUNTING ARRANGEMENT

Recommended isolated mounting when screw is at heatsink potential. 6-32 hardware is used.

A conical washer should be used to apply proper force to the device. Screw should not be tightened with any type of air-forced torque or equipment that may cause high impact on device package.

The interface should apply a layer of thermal grease or a highly conductive thermal pad for better heat dissipation.

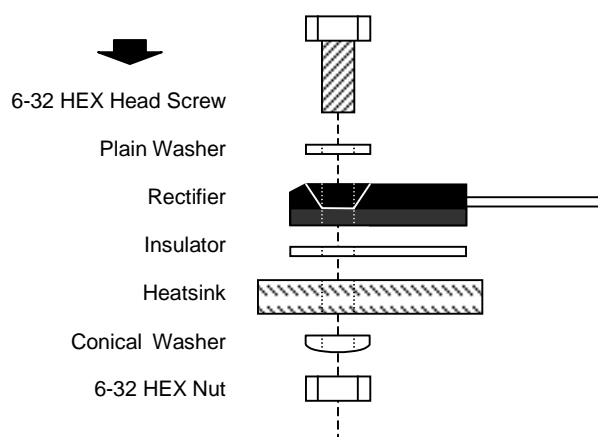

ORDERING INFORMATION

Product No.	Package Type	Shipping Quantity
U30D05C	TO-3P	30 Units/Tube
U30D10C	TO-3P	30 Units/Tube
U30D15C	TO-3P	30 Units/Tube
U30D20C	TO-3P	30 Units/Tube
U30D30C	TO-3P	30 Units/Tube
U30D40C	TO-3P	30 Units/Tube
U30D50C	TO-3P	30 Units/Tube
U30D60C	TO-3P	30 Units/Tube

1. Shipping quantity given is for minimum packing quantity only. For minimum order quantity, please consult the Sales Department.
2. **To order RoHS / Lead Free version (with Lead Free finish), add "-LF" suffix to part number above. For example, U30D05C-LF.**

Won-Top Electronics Co., Ltd (WTE) has checked all information carefully and believes it to be correct and accurate. However, WTE cannot assume any responsibility for inaccuracies. Furthermore, this information does not give the purchaser of semiconductor devices any license under patent rights to manufacturer. WTE reserves the right to change any or all information herein without further notice.

WARNING: DO NOT USE IN LIFE SUPPORT EQUIPMENT. WTE power semiconductor products are not authorized for use as critical components in life support devices or systems without the express written approval.

Won-Top Electronics Co., Ltd.

No. 44 Yu Kang North 3rd Road, Chine Chen Dist., Kaohsiung, Taiwan

Phone: 886-7-822-5408 or 886-7-822-5410

Fax: 886-7-822-5417

Email: sales@wontop.com

Internet: <http://www.wontop.com>

We power your everyday.