

## 600W TRANSIENT VOLTAGE SUPPRESSOR

### Features

- Glass Passivated Die Construction
- 600W Peak Pulse Power Dissipation
- 6.8V – 440V Standoff Voltage
- Uni- and Bi-Directional Versions Available
- Excellent Clamping Capability
- Fast Response Time
- Plastic Case Material has UL Flammability Classification Rating 94V-O

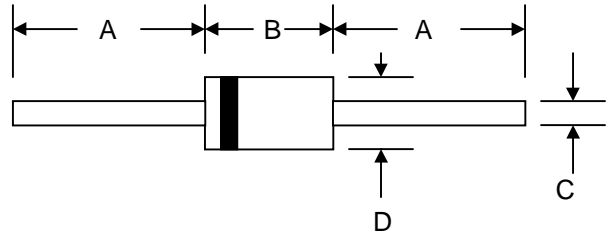

### Mechanical Data

- Case: DO-15, Molded Plastic
- Terminals: Axial Leads, Solderable per MIL-STD-202, Method 208
- Polarity: Cathode Band Except Bi-Directional
- Marking: Type Number
- Weight: 0.40 grams (approx.)
- **Lead Free: For RoHS / Lead Free Version, Add "-LF" Suffix to Part Number, See Page 6**

DO-15		
Dim	Min	Max
A	25.4	—
B	5.50	7.62
C	0.71	0.864
D	2.60	3.60
All Dimensions in mm		

"C" Suffix Designates Bi-directional Devices  
 "A" Suffix Designates 5% Tolerance Devices  
 No Suffix Designates 10% Tolerance Devices

### Maximum Ratings and Electrical Characteristics @ $T_A=25^\circ\text{C}$ unless otherwise specified

Characteristic	Symbol	Value	Unit
Peak Pulse Power Dissipation at $T_A = 25^\circ\text{C}$ (Note 1, 2, 5) Figure 3	PPPM	600 Minimum	W
Peak Forward Surge Current (Note 3)	IFSM	100	A
Peak Pulse Current on 10/1000 $\mu\text{S}$ Waveform (Note 1) Figure 1	IPPM	See Table 1	A
Steady State Power Dissipation (Note 2, 4)	PM(AV)	5.0	W
Operating and Storage Temperature Range	$T_j, T_{STG}$	-65 to +175	$^\circ\text{C}$

- Note: 1. Non-repetitive current pulse per Figure 1 and derated above  $T_A = 25^\circ\text{C}$  per Figure 4.  
 2. Mounted on 40mm<sup>2</sup> copper pad.  
 3. 8.3ms single half sine-wave duty cycle = 4 pulses per minutes maximum.  
 4. Lead temperature at 75 $^\circ\text{C}$ .  
 5. Peak pulse power waveform is 10/1000 $\mu\text{S}$ .

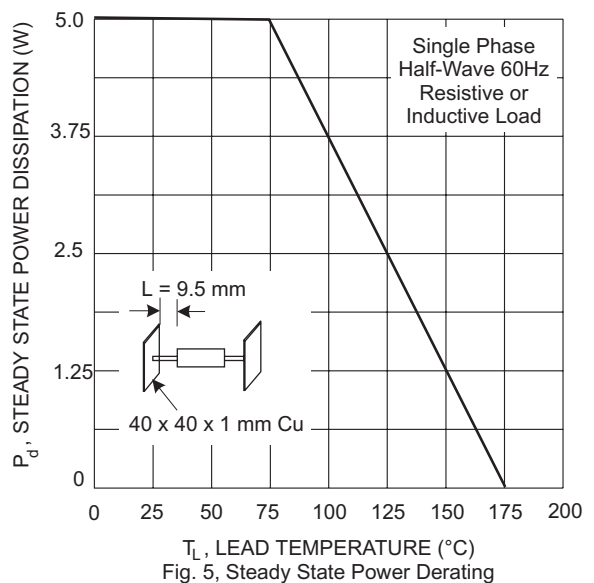
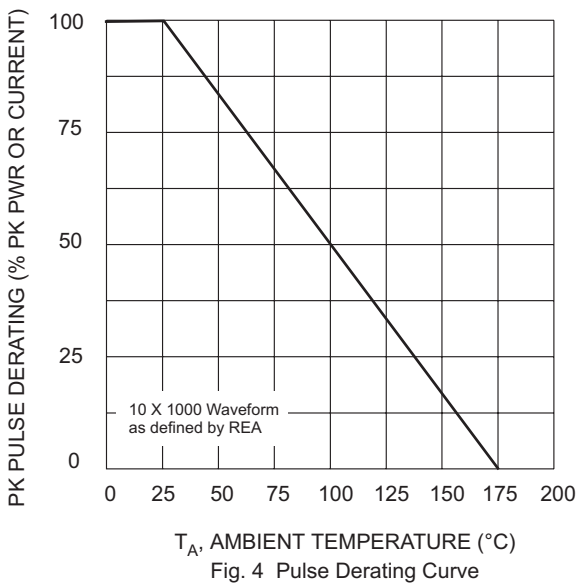
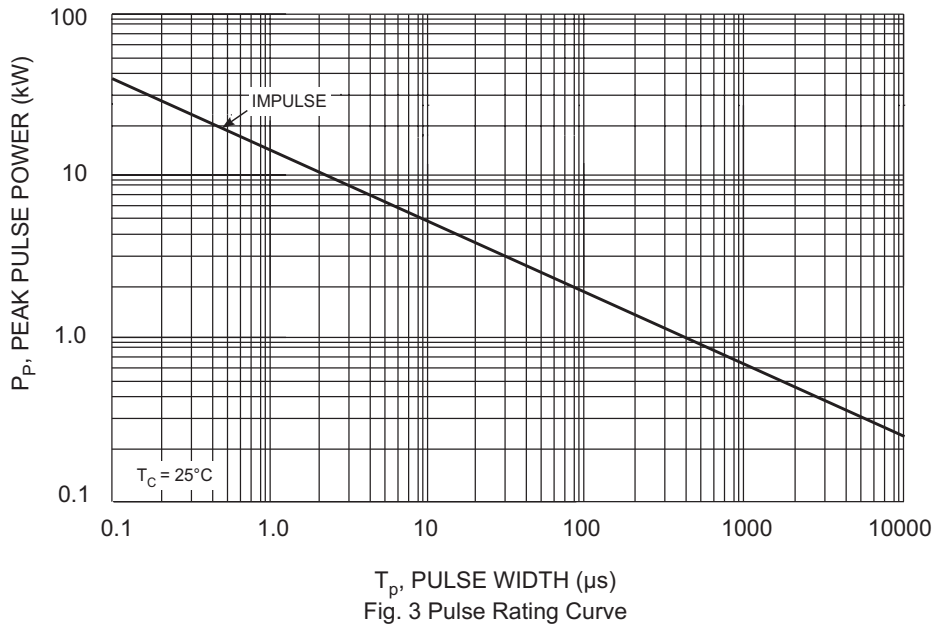
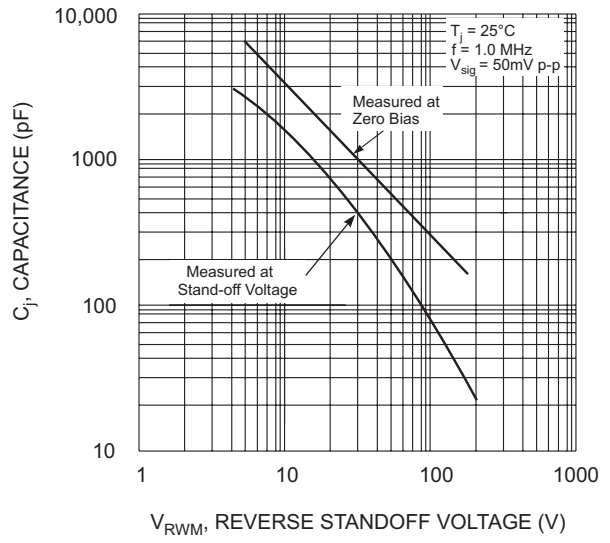
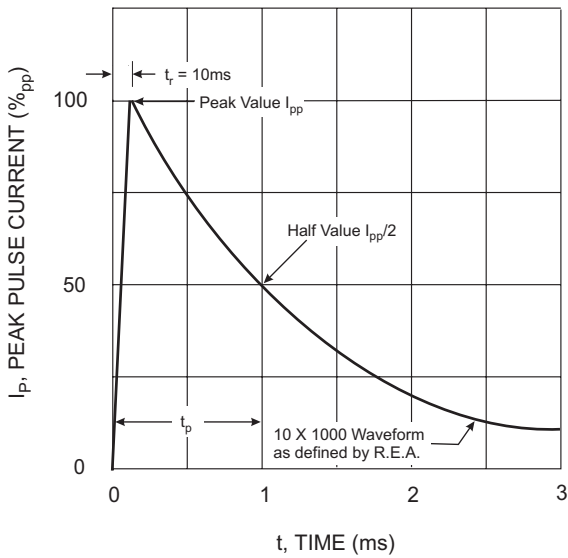

## UNI-DIRECTIONAL 600 WATT AXIAL LEAD TVS

UNI-DIRECTIONAL PART NUMBER	REVERSE STAND-OFF VOLTAGE VRWM (V)	BREAKDOWN VOLTAGE VBR (V) MIN. @IT	BREAKDOWN VOLTAGE VBR (V) MAX. @IT	TEST CURRENT IT (mA)	MAXIMUM CLAMPING VOLTAGE @Ipp Vc (V)	PEAK PULSE CURRENT Ipp (A)	REVERSE LEAKAGE @VRWM IR (uA)
P6KE6.8	5.50	6.12	7.48	10	10.8	56.00	1000
P6KE6.8A	5.80	6.45	7.14	10	10.5	57.00	1000
P6KE7.5	6.05	6.75	8.25	10	11.7	51.00	500
P6KE7.5A	6.40	7.13	7.88	10	11.3	53.00	500
P6KE8.2	6.63	7.38	9.02	10	12.5	48.00	200
P6KE8.2A	7.02	7.79	8.61	10	12.1	50.00	200
P6KE9.1	7.37	8.19	10.00	1	13.8	44.00	50
P6KE9.1A	7.78	8.65	9.50	1	13.4	45.00	50
P6KE10	8.10	9.00	11.00	1	15.0	40.00	10
P6KE10A	8.55	9.50	10.50	1	14.5	41.00	10
P6KE11	8.92	9.90	12.10	1	16.2	37.00	5
P6KE11A	9.40	10.50	11.60	1	15.6	38.00	5
P6KE12	9.72	10.80	13.20	1	17.3	35.00	5
P6KE12A	10.20	11.40	12.60	1	16.7	36.00	5
P6KE13	10.50	11.70	14.30	1	19.0	32.00	5
P6KE13A	11.10	12.40	13.70	1	18.2	33.00	5
P6KE15	12.10	13.50	16.50	1	22.0	27.00	1
P6KE15A	12.80	14.30	15.80	1	21.2	28.00	1
P6KE16	12.90	14.40	17.60	1	23.5	26.00	1
P6KE16A	13.60	15.20	16.80	1	22.5	27.00	1
P6KE18	14.50	16.20	19.80	1	26.5	23.00	1
P6KE18A	15.30	17.10	18.90	1	25.2	24.00	1
P6KE20	16.20	18.00	22.00	1	29.1	21.00	1
P6KE20A	17.10	19.00	21.00	1	27.7	22.00	1
P6KE22	17.80	19.80	24.20	1	31.9	19.00	1
P6KE22A	18.80	20.90	23.10	1	30.6	20.00	1
P6KE24	19.40	21.60	26.40	1	34.7	17.00	1
P6KE24A	20.50	22.80	25.20	1	33.2	18.00	1
P6KE27	21.80	24.30	29.70	1	39.1	15.00	1
P6KE27A	23.10	25.70	28.40	1	37.5	16.00	1
P6KE30	24.30	27.00	33.00	1	43.5	14.00	1
P6KE30A	25.60	28.50	31.50	1	41.4	14.40	1
P6KE33	26.80	29.70	36.30	1	47.7	12.60	1
P6KE33A	28.20	31.40	34.70	1	45.7	13.20	1
P6KE36	29.10	32.40	39.60	1	52.0	11.60	1
P6KE36A	30.80	34.20	37.80	1	49.9	12.00	1
P6KE39	31.60	35.10	42.90	1	56.4	10.60	1
P6KE39A	33.30	37.10	41.00	1	53.9	11.20	1
P6KE43	34.80	38.70	47.30	1	61.9	9.60	1
P6KE43A	36.80	40.90	45.20	1	59.3	10.10	1
P6KE47	38.10	42.30	51.70	1	67.8	8.90	1
P6KE47A	40.20	44.70	49.40	1	64.8	9.30	1
P6KE51	41.30	45.90	56.10	1	73.5	8.20	1
P6KE51A	43.60	48.50	53.60	1	70.1	8.60	1
P6KE56	45.60	50.40	61.60	1	80.5	7.40	1
P6KE56A	47.80	53.20	58.80	1	77.0	7.80	1
P6KE62	50.20	55.80	68.20	1	89.0	6.80	1
P6KE62A	53.00	58.90	65.10	1	85.0	7.10	1
P6KE68	55.10	61.20	74.80	1	98.0	6.10	1
P6KE68A	58.10	64.60	71.40	1	92.0	6.50	1
P6KE75	60.70	67.50	82.50	1	108.0	5.50	1
P6KE75A	64.10	71.30	78.80	1	103.0	5.80	1
P6KE82	66.40	73.80	90.20	1	118.0	5.10	1
P6KE82A	70.10	77.90	86.10	1	113.0	5.30	1
P6KE91	73.70	81.90	100.00	1	131.0	4.50	1
P6KE91A	77.80	86.50	95.50	1	125.0	4.80	1
P6KE100	81.00	90.00	110.00	1	144.0	4.20	1
P6KE100A	85.50	95.00	105.00	1	137.0	4.40	1
P6KE110	89.20	99.00	121.00	1	158.0	3.80	1
P6KE110A	94.00	105.00	116.00	1	152.0	4.00	1
P6KE120	97.20	108.00	132.00	1	173.0	3.50	1
P6KE120A	102.00	114.00	126.00	1	165.0	3.60	1
P6KE130	105.00	117.00	143.00	1	187.0	3.20	1
P6KE130A	111.00	124.00	137.00	1	179.0	3.30	1
P6KE150	121.00	135.00	165.00	1	215.0	2.80	1
P6KE150A	128.00	143.00	158.00	1	207.0	2.90	1
P6KE160	130.00	144.00	176.00	1	230.0	2.60	1
P6KE160A	136.00	152.00	168.00	1	219.0	2.70	1
P6KE170	138.00	153.00	187.00	1	244.0	2.50	1
P6KE170A	145.00	162.00	179.00	1	234.0	2.60	1
P6KE180	146.00	162.00	198.00	1	258.0	2.30	1
P6KE180A	154.00	171.00	189.00	1	246.0	2.40	1
P6KE200	162.00	180.00	220.00	1	287.0	2.10	1
P6KE200A	171.00	190.00	210.00	1	274.0	2.20	1
P6KE220	175.00	198.00	242.00	1	344.0	1.80	1
P6KE220A	185.00	209.00	231.00	1	328.0	1.90	1
P6KE250	202.00	225.00	275.00	1	360.0	1.70	1
P6KE250A	214.00	237.00	263.00	1	344.0	1.80	1
P6KE300	243.00	270.00	330.00	1	430.0	1.40	1
P6KE300A	256.00	285.00	315.00	1	414.0	1.50	1
P6KE350	284.00	315.00	385.00	1	504.0	1.20	1
P6KE350A	300.00	332.00	368.00	1	482.0	1.30	1
P6KE400	324.00	360.00	440.00	1	574.0	1.05	1
P6KE400A	342.00	380.00	420.00	1	548.0	1.10	1
P6KE440	356.00	396.00	484.00	1	631.0	0.99	1
P6KE440A	376.00	418.00	462.00	1	600.0	1.04	1

## BI-DIRECTIONAL 600 WATT AXIAL LEAD TVS

BI-DIRECTIONAL PART NUMBER	REVERSE STAND-OFF VOLTAGE VRWM (V)	BREAKDOWN VOLTAGE VBR (V) MIN. @IT	BREAKDOWN VOLTAGE VBR (V) MAX. @IT	TEST CURRENT IT (mA)	MAXIMUM CLAMPING VOLTAGE @Ipp Vc (V)	PEAK PULSE CURRENT Ipp (A)	REVERSE LEAKAGE @VRWM IR (uA)
P6KE6.8C	5.50	6.12	7.48	10	10.8	56.00	2000
P6KE6.8CA	5.80	6.45	7.14	10	10.5	57.00	2000
P6KE7.5C	6.05	6.75	8.25	10	11.7	51.00	1000
P6KE7.5CA	6.40	7.13	7.88	10	11.3	53.00	1000
P6KE8.2C	6.63	7.38	9.02	10	12.5	48.00	400
P6KE8.2CA	7.02	7.79	8.61	10	12.1	50.00	400
P6KE9.1C	7.37	8.19	10.00	1	13.8	44.00	100
P6KE9.1CA	7.78	8.65	9.50	1	13.4	45.00	100
P6KE10C	8.10	9.00	11.00	1	15.0	40.00	20
P6KE10CA	8.55	9.50	10.50	1	14.5	41.00	20
P6KE11C	8.92	9.90	12.10	1	16.2	37.00	10
P6KE11CA	9.40	10.50	11.60	1	15.6	38.00	10
P6KE12C	9.72	10.80	13.20	1	17.3	35.00	5
P6KE12CA	10.20	11.40	12.60	1	16.7	36.00	5
P6KE13C	10.50	11.70	14.30	1	19.0	32.00	5
P6KE13CA	11.10	12.40	13.70	1	18.2	33.00	5
P6KE15C	12.10	13.50	16.50	1	22.0	27.00	1
P6KE15CA	12.80	14.30	15.80	1	21.2	28.00	1
P6KE16C	12.90	14.40	17.60	1	23.5	26.00	1
P6KE16CA	13.60	15.20	16.80	1	22.5	27.00	1
P6KE18C	14.50	16.20	19.80	1	26.5	23.00	1
P6KE18CA	15.30	17.10	18.90	1	25.2	24.00	1
P6KE20C	16.20	18.00	22.00	1	29.1	21.00	1
P6KE20CA	17.10	19.00	21.00	1	27.7	22.00	1
P6KE22C	17.80	19.80	24.20	1	31.9	19.00	1
P6KE22CA	18.80	20.90	23.10	1	30.6	20.00	1
P6KE24C	19.40	21.60	26.40	1	34.7	17.00	1
P6KE24CA	20.50	22.80	25.20	1	33.2	18.00	1
P6KE27C	21.80	24.30	29.70	1	39.1	15.00	1
P6KE27CA	23.10	25.70	28.40	1	37.5	16.00	1
P6KE30C	24.30	27.00	33.00	1	43.5	14.00	1
P6KE30CA	25.60	28.50	31.50	1	41.4	14.40	1
P6KE33C	26.80	29.70	36.30	1	47.7	12.60	1
P6KE33CA	28.20	31.40	34.70	1	45.7	13.20	1
P6KE36C	29.10	32.40	39.60	1	52.0	11.60	1
P6KE36CA	30.80	34.20	37.80	1	49.9	12.00	1
P6KE39C	31.60	35.10	42.90	1	56.4	10.60	1
P6KE39CA	33.30	37.10	41.00	1	53.9	11.20	1
P6KE43C	34.80	38.70	47.30	1	61.9	9.60	1
P6KE43CA	36.80	40.90	45.20	1	59.3	10.10	1
P6KE47C	38.10	42.30	51.70	1	67.8	8.90	1
P6KE47CA	40.20	44.70	49.40	1	64.8	9.30	1
P6KE51C	41.30	45.90	56.10	1	73.5	8.20	1
P6KE51CA	43.60	48.50	53.60	1	70.1	8.60	1
P6KE56C	45.60	50.40	61.60	1	80.5	7.40	1
P6KE56CA	47.80	53.20	58.80	1	77.0	7.80	1
P6KE62C	50.20	55.80	68.20	1	89.0	6.80	1
P6KE62CA	53.00	58.90	65.10	1	85.0	7.10	1
P6KE68C	55.10	61.20	74.80	1	98.0	6.10	1
P6KE68CA	58.10	64.60	71.40	1	92.0	6.50	1
P6KE75C	60.70	67.50	82.50	1	108.0	5.50	1
P6KE75CA	64.10	71.30	78.80	1	103.0	5.80	1
P6KE82C	66.40	73.80	90.20	1	118.0	5.10	1
P6KE82CA	70.10	77.90	86.10	1	113.0	5.30	1
P6KE91C	73.70	81.90	100.00	1	131.0	4.50	1
P6KE91CA	77.80	86.50	95.50	1	125.0	4.80	1
P6KE100C	81.00	90.00	110.00	1	144.0	4.20	1
P6KE100CA	85.50	95.00	105.00	1	137.0	4.40	1
P6KE110C	89.20	99.00	121.00	1	158.0	3.80	1
P6KE110CA	94.00	105.00	116.00	1	152.0	4.00	1
P6KE120C	97.20	108.00	132.00	1	173.0	3.50	1
P6KE120CA	102.00	114.00	126.00	1	165.0	3.60	1
P6KE130C	105.00	117.00	143.00	1	187.0	3.20	1
P6KE130CA	111.00	124.00	137.00	1	179.0	3.30	1
P6KE150C	121.00	135.00	165.00	1	215.0	2.80	1
P6KE150CA	128.00	143.00	158.00	1	207.0	2.90	1
P6KE160C	130.00	144.00	176.00	1	230.0	2.60	1
P6KE160CA	136.00	152.00	168.00	1	219.0	2.70	1
P6KE170C	138.00	153.00	187.00	1	244.0	2.50	1
P6KE170CA	145.00	162.00	179.00	1	234.0	2.60	1
P6KE180C	146.00	162.00	198.00	1	258.0	2.30	1
P6KE180CA	154.00	171.00	189.00	1	246.0	2.40	1
P6KE200C	162.00	180.00	220.00	1	287.0	2.10	1
P6KE200CA	171.00	190.00	210.00	1	274.0	2.20	1
P6KE220C	175.00	198.00	242.00	1	344.0	1.80	1
P6KE220CA	185.00	209.00	231.00	1	328.0	1.90	1
P6KE250C	202.00	225.00	275.00	1	360.0	1.70	1
P6KE250CA	214.00	237.00	263.00	1	344.0	1.80	1
P6KE300C	243.00	270.00	330.00	1	430.0	1.40	1
P6KE300CA	256.00	285.00	315.00	1	414.0	1.50	1
P6KE350C	284.00	315.00	385.00	1	504.0	1.20	1
P6KE350CA	300.00	332.00	368.00	1	482.0	1.30	1
P6KE400C	324.00	360.00	440.00	1	574.0	1.05	1
P6KE400CA	342.00	380.00	420.00	1	548.0	1.10	1
P6KE440C	356.00	396.00	484.00	1	631.0	0.99	1
P6KE440CA	376.00	418.00	462.00	1	600.0	1.04	1

## MARKING INFORMATION

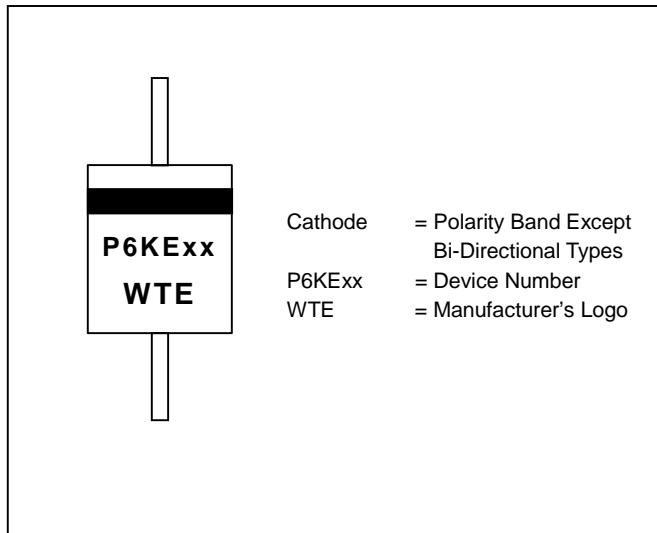

## TAPING SPECIFICATIONS

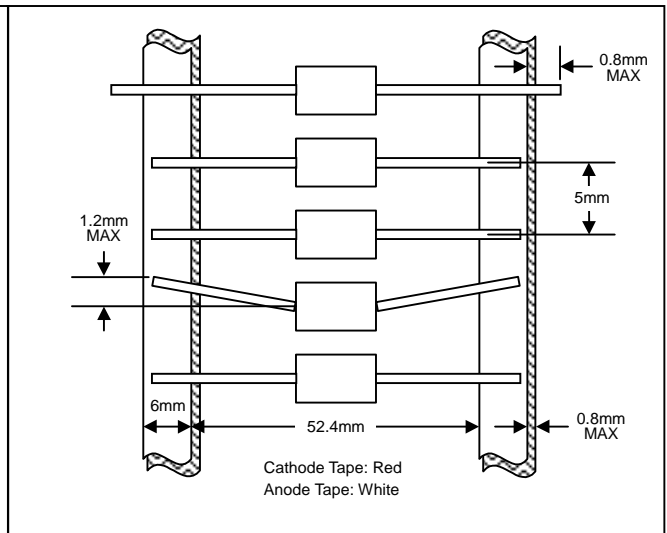

## PACKAGING INFORMATION

### TAPE & REEL

330mm  
 Product ID Label  
 80±5mm

### TAPE & BOX

150mm  
 Product ID Label  
 Inspection Hole (both ends)  
 255mm  
 75mm

### BULK

25mm  
 200mm  
 85mm

Packaging	Reel Diameter / Box Size (mm)	Quantity (PCS)	Carton Size (mm)	Quantity (PCS)	Approx. Gross Weight (KG)
<b>TAPE &amp; REEL</b>	330	4,000	370 x 370 x 420	20,000	12.0
<b>TAPE &amp; BOX</b>	255 x 75 x 150	3,000	400 x 273 x 415	30,000	15.0
<b>BULK</b>	200 x 85 x 25	1,000	459 x 214 x 256	40,000	17.5

**Note:** 1. Paper reel, white or gray color. Core material: plastic or metal.  
 2. Components are packed in accordance with EIA standard RS-296-E.

## ORDERING INFORMATION

Product No.	Package Type	Shipping Quantity
P6KExx-T3	DO-15	4000/Tape & Reel
<b>P6KExx-TB</b>	DO-15	3000/Tape & Box
P6KExx	DO-15	1000 Units/Box

1. Products listed in **bold** are WTE **Preferred** devices.
2. Shipping quantity given is for minimum packing quantity only. For minimum order quantity, please consult the Sales Department.
3. **To order RoHS / Lead Free version, add "-LF" suffix to part number above. For example, P6KE6.8-TB-LF.**

Won-Top Electronics Co., Ltd (WTE) has checked all information carefully and believes it to be correct and accurate. However, WTE cannot assume any responsibility for inaccuracies. Furthermore, this information does not give the purchaser of semiconductor devices any license under patent rights to manufacturer. WTE reserves the right to change any or all information herein without further notice.

**WARNING:** DO NOT USE IN LIFE SUPPORT EQUIPMENT. WTE power semiconductor products are not authorized for use as critical components in life support devices or systems without the express written approval.

**Won-Top Electronics Co., Ltd.**

No. 44 Yu Kang North 3rd Road, Chine Chen Dist., Kaohsiung, Taiwan

**Phone:** 886-7-822-5408 or 886-7-822-5410

**Fax:** 886-7-822-5417

**Email:** sales@wontop.com

**Internet:** <http://www.wontop.com>

*We power your everyday.*