

200mW SURFACE MOUNT ZENER DIODE

Features

- Planar Die Construction
- 200mW Power Dissipation
- 2.4 – 51V Nominal Zener Voltage
- 5% Standard Vz Tolerance
- Designed for Surface Mount Application
- Plastic Material – UL Recognition Flammability Classification 94V-O

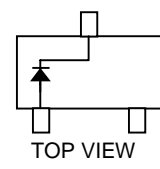
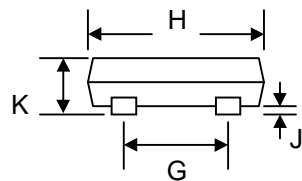
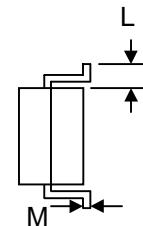
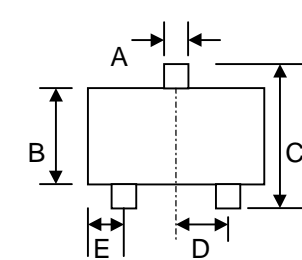

SOT-323		
Dim	Min	Max
A	0.30	0.40
B	1.15	1.35
C	2.00	2.20
D	0.65 Nominal	
E	0.30	0.40
G	1.20	1.40
H	1.80	2.20
J	—	0.10
K	0.90	1.10
L	0.25	—
M	0.05	0.15
All Dimensions in mm		

Mechanical Data

- Case: SOT-323, Molded Plastic
- Terminals: Plated Leads Solderable per MIL-STD-202, Method 208
- Polarity: See Diagram
- Weight: 0.006 grams (approx.)
- Mounting Position: Any
- Marking: Device Code, See Page 2
- **Lead Free: For RoHS / Lead Free Version, Add “-LF” Suffix to Part Number, See Page 5**

Maximum Ratings @ $T_A=25^\circ\text{C}$ unless otherwise specified

Characteristic	Symbol	Value	Unit
Peak Pulse Power Dissipation at $T_A = 25^\circ\text{C}$ (Note 1)	P_d	200	mW
Forward Voltage @ $I_F = 10\text{mA}$	V_F	0.9	V
Thermal Resistance Junction to Ambient (Note 1)	$R_{\theta JA}$	625	$^\circ\text{C/W}$
Operating and Storage Temperature Range	T_j, T_{STG}	-65 to +150	$^\circ\text{C}$

Note: 1. Valid provided that device terminals are kept at ambient temperature.

Electrical Characteristics @ $T_A=25^{\circ}\text{C}$ unless otherwise specified

Type Number (Note 1)	Device Marking Code	Zener Voltage Range (Note 2)			Maximum Zener Impedance (Note 3)				Max Reverse Leakage Current		Temp. Coefficient of Zener Voltage @ I_{zT} mV / $^{\circ}\text{C}$	
		V_z @ I_{zT}			Z_{zT} @ I_{zT}		Z_{zK} @ I_{zK}		I_R	@ V_R	Min	Max
		Nom (V)	Min (V)	Max (V)	(Ω)	(mA)	(Ω)	(mA)	(μA)	(V)		
BZX84C2V4W	W1	2.4	2.28	2.52	100	5.0	600	1.0	50	1.0	-3.5	0
BZX84C2V7W	W2	2.7	2.57	2.84	100	5.0	600	1.0	20	1.0	-3.5	0
BZX84C3W	W3	3.0	2.85	3.15	95	5.0	600	1.0	10	1.0	-3.5	0
BZX84C3V3W	W4	3.3	3.14	3.47	95	5.0	600	1.0	5.0	1.0	-3.5	0
BZX84C3V6W	W5	3.6	3.42	3.78	90	5.0	600	1.0	5.0	1.0	-3.5	0
BZX84C3V9W	W6	3.9	3.71	4.10	90	5.0	600	1.0	3.0	1.0	-3.5	0
BZX84C4V3W	W7	4.3	4.09	4.52	90	5.0	600	1.0	3.0	1.0	-3.5	0
BZX84C4V7W	W8	4.7	4.47	4.94	80	5.0	500	1.0	3.0	2.0	-3.5	0.2
BZX84C5V1W	W9	5.1	4.85	5.36	60	5.0	480	1.0	2.0	2.0	-2.7	1.2
BZX84C5V6W	WA	5.6	5.32	5.88	40	5.0	400	1.0	1.0	2.0	-2.0	2.5
BZX84C6V2W	WB	6.2	5.89	6.51	10	5.0	150	1.0	3.0	4.0	0.4	3.7
BZX84C6V8W	WC	6.8	6.46	7.14	15	5.0	80	1.0	2.0	4.0	1.2	4.5
BZX84C7V5W	WD	7.5	7.13	7.88	15	5.0	80	1.0	1.0	5.0	2.5	5.3
BZX84C8V2W	WE	8.2	7.79	8.61	15	5.0	80	1.0	0.7	5.0	3.2	6.2
BZX84C9V1W	WF	9.1	8.65	9.56	15	5.0	100	1.0	0.5	6.0	3.8	7.0
BZX84C10W	WG	10	9.50	10.50	20	5.0	150	1.0	0.2	7.0	4.5	8.0
BZX84C11W	WH	11	10.45	11.55	20	5.0	150	1.0	0.1	8.0	5.4	9.0
BZX84C12W	WI	12	11.40	12.60	25	5.0	150	1.0	0.1	8.0	6.0	10
BZX84C13W	WK	13	12.35	13.65	30	5.0	170	1.0	0.1	8.0	7.0	11
BZX84C15W	WL	15	14.25	15.75	30	5.0	200	1.0	0.1	10.5	9.2	13
BZX84C16W	WM	16	15.20	16.80	40	5.0	200	1.0	0.1	11.2	10.4	14
BZX84C18W	WN	18	17.10	18.90	45	5.0	225	1.0	0.1	12.6	12.4	16
BZX84C20W	WO	20	19.00	21.00	55	5.0	225	1.0	0.1	14	14.4	18
BZX84C22W	WP	22	20.90	23.10	55	5.0	250	1.0	0.1	15.4	16.4	20
BZX84C24W	WR	24	22.80	25.20	70	5.0	250	1.0	0.1	16.8	18.4	22
BZX84C27W	WS	27	25.65	28.35	80	5.0	300	1.0	0.1	18.9	21.4	25.3
BZX84C30W	WT	30	28.50	31.50	80	5.0	300	1.0	0.1	21	24.4	29.4
BZX84C33W	WU	33	31.35	34.65	80	5.0	325	1.0	0.1	23.1	27.4	33.4
BZX84C36W	WW	36	34.20	37.80	90	5.0	350	1.0	0.1	25.2	30.4	37.4
BZX84C39W	WX	39	37.05	40.95	130	5.0	350	1.0	0.1	27.3	33.4	41.2
BZX84C43W	WY	43	40.85	45.15	150	5.0	375	1.0	0.1	30.1	10.0	12
BZX84C47W	WZ	47	44.65	49.35	170	5.0	375	1.0	0.1	32.9	10.0	12
BZX84C51W	XA	51	48.45	53.55	100	5.0	400	1.0	0.1	38	10.0	12

Note: 1. Type numbers listed have standard tolerance on the nominal zener voltage of $\pm 5\%$.

2. Measured with pulses $t_p = 5\text{ms}$.

3. $f = 1\text{KHz}$

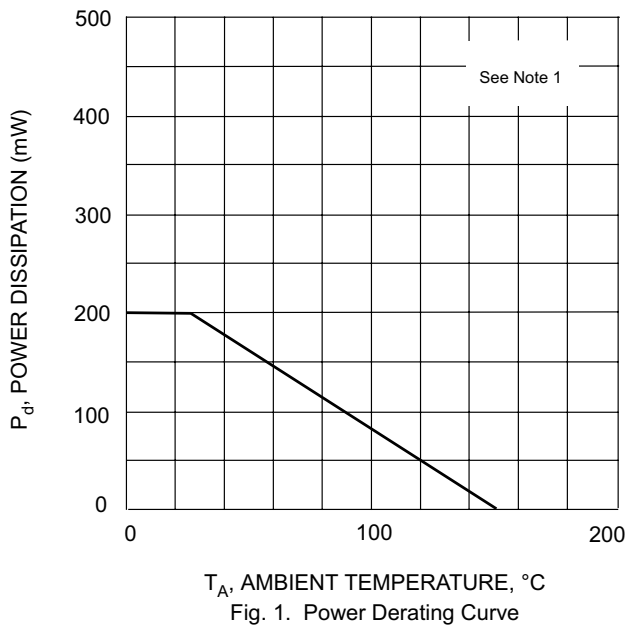

Fig. 1. Power Derating Curve

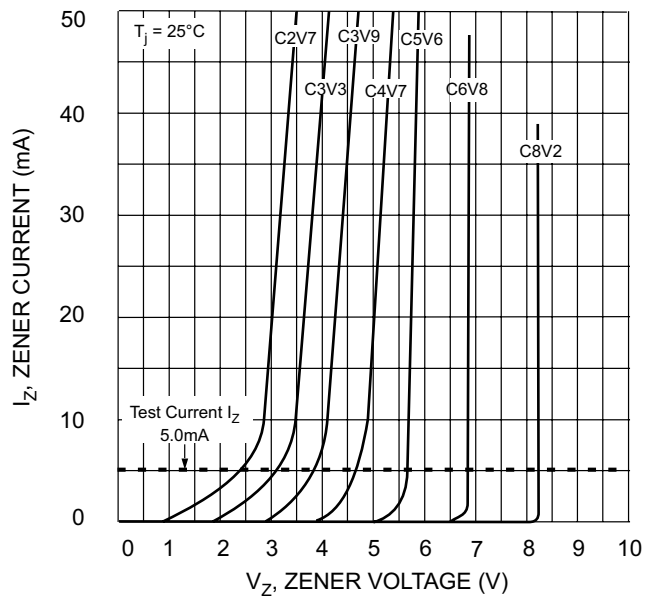

Fig. 2. Zener Breakdown Characteristics

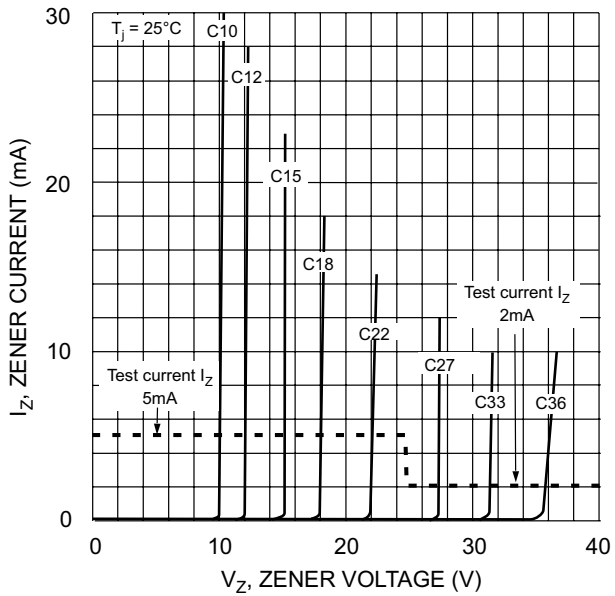
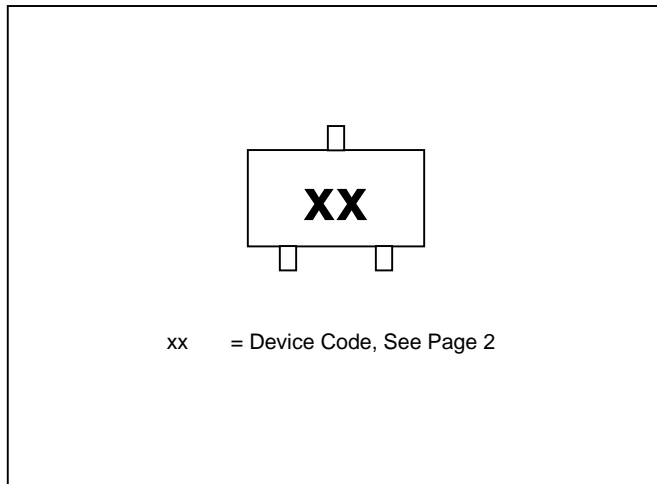
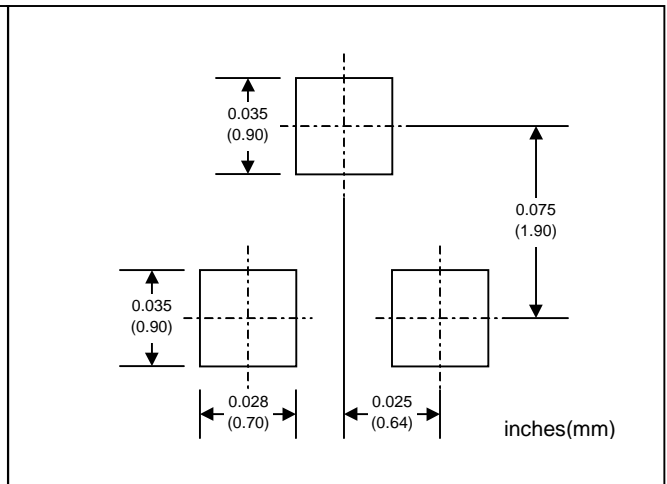

Fig. 3. Zener Breakdown Characteristics

MARKING INFORMATION



RECOMMENDED FOOTPRINT



PACKAGING INFORMATION

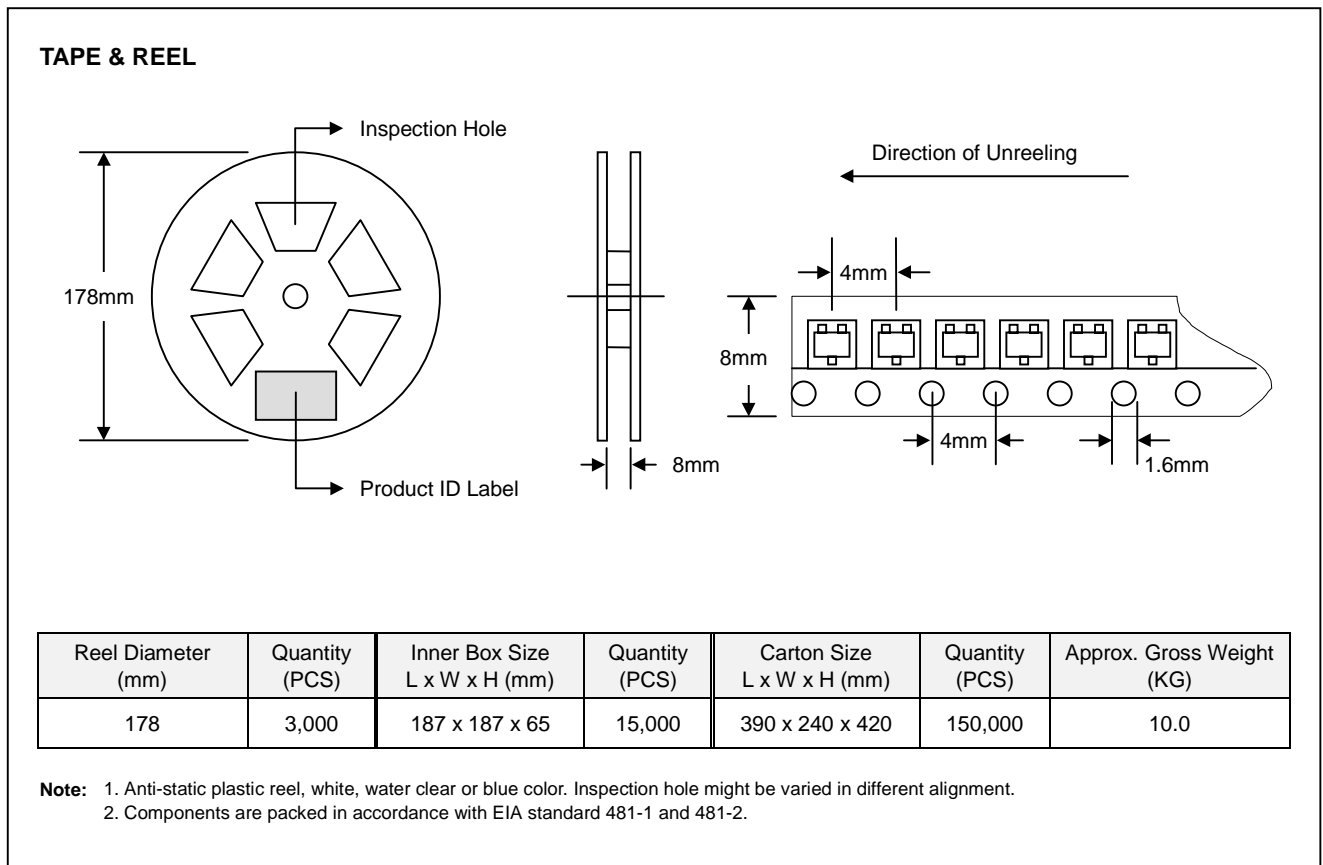

ORDERING INFORMATION

Product No.	Package Type	Shipping Quantity
BZX84CxxW-T1	SOT-323	3000/Tape & Reel

1. Shipping quantity given is for minimum packing quantity only. For minimum order quantity, please consult the Sales Department.
2. **To order RoHS / Lead Free version (with Lead Free finish), add "-LF" suffix to part number above. For example, BZX84C2V4W-T1-LF.**

Won-Top Electronics Co., Ltd (WTE) has checked all information carefully and believes it to be correct and accurate. However, WTE cannot assume any responsibility for inaccuracies. Furthermore, this information does not give the purchaser of semiconductor devices any license under patent rights to manufacturer. WTE reserves the right to change any or all information herein without further notice.

WARNING: DO NOT USE IN LIFE SUPPORT EQUIPMENT. WTE power semiconductor products are not authorized for use as critical components in life support devices or systems without the express written approval.

Won-Top Electronics Co., Ltd.

No. 44 Yu Kang North 3rd Road, Chine Chen Dist., Kaohsiung, Taiwan

Phone: 886-7-822-5408 or 886-7-822-5410

Fax: 886-7-822-5417

Email: sales@wontop.com

Internet: <http://www.wontop.com>

We power your everyday.