

SURFACE MOUNT FAST SWITCHING DIODE

Features

- High Conductance
- Fast Switching
- Surface Mount Package Ideally Suited for Automatic Insertion
- For General Purpose and Switching
- Plastic Material – UL Recognition Flammability Classification 94V-O

Mechanical Data

- Case: SOT-23, Molded Plastic
- Terminals: Plated Leads Solderable per MIL-STD-202, Method 208
- Polarity: See Diagram
- Weight: 0.008 grams (approx.)
- Mounting Position: Any
- Marking: Device Code, See Page 3
- **Lead Free: For RoHS / Lead Free Version, Add "-LF" Suffix to Part Number, See Page 4**

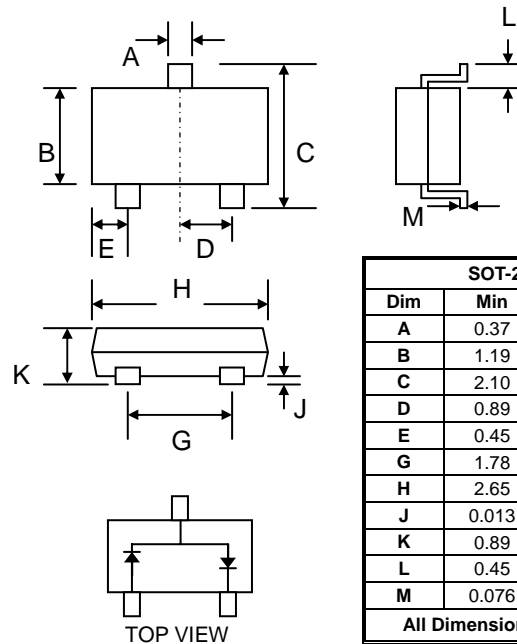

SOT-23		
Dim	Min	Max
A	0.37	0.51
B	1.19	1.40
C	2.10	2.50
D	0.89	1.05
E	0.45	0.61
G	1.78	2.05
H	2.65	3.05
J	0.013	0.15
K	0.89	1.10
L	0.45	0.61
M	0.076	0.178
All Dimensions in mm		

Maximum Ratings @ $T_A=25^{\circ}\text{C}$ unless otherwise specified

Characteristic	Symbol	Value	Unit
Non-Repetitive Peak Reverse Voltage	V_{RM}	100	V
Peak Repetitive Reverse Voltage	V_{RRM}	75	V
Working Peak Reverse Voltage	V_{RWM}		
DC Blocking Voltage	V_R		
Forward Continuous Current (Note 1)	I_F	300	mA
Average Rectified Output Current (Note 1)	I_O	150	mA
Peak Forward Surge Current (Note 1)	I_{FSM}	2.0	A
Power Dissipation (Note 1)	P_d	350	mW
Typical Thermal Resistance, Junction to Ambient Air (Note 1)	$R_{\theta JA}$	357	K/W
Operating and Storage Temperature Range	T_j, T_{STG}	-65 to +150	$^{\circ}\text{C}$

Electrical Characteristics @ $T_A=25^{\circ}\text{C}$ unless otherwise specified

Characteristic	Symbol	Min	Max	Unit	Test Condition
Forward Voltage	V_F	—	0.855 1.0	V	@ $I_F = 10\text{mA}$ @ $I_F = 50\text{mA}$
Reverse Leakage Current	I_R	—	2.5	μA	@ $V_R = 75\text{V}$
Junction Capacitance	C_j	—	2.0	pF	$V_R = 0\text{V}, f = 1.0\text{MHz}$
Reverse Recovery Time	t_{rr}	—	6.0	nS	$I_F = I_R = 10\text{mA},$ $I_{RR} = 0.1 \times I_R, R_L = 100\Omega$

Note: 1. Device mounted on fiberglass substrate 40 x 40 x 1.5mm.

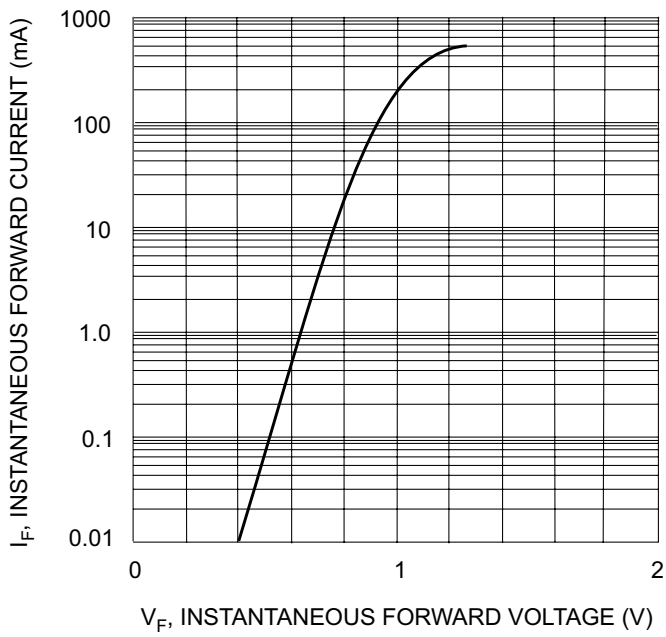

Fig. 1 Forward Characteristics

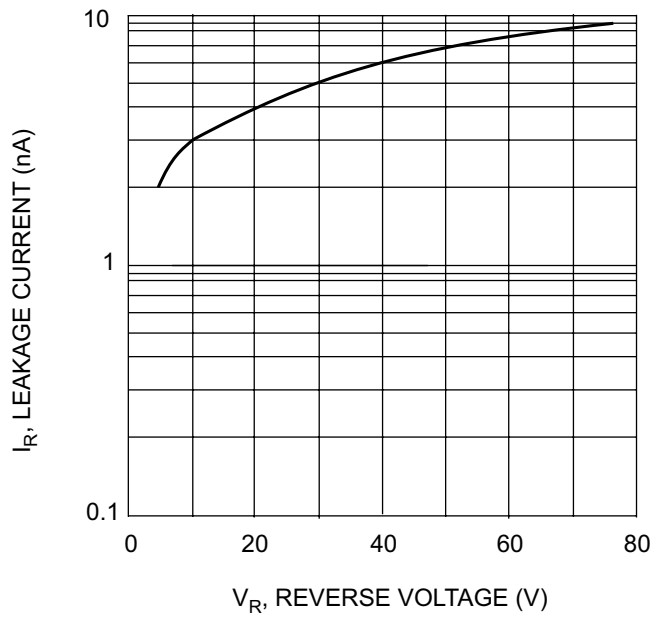

Fig. 2 Typical Leakage Current vs Reverse Voltage

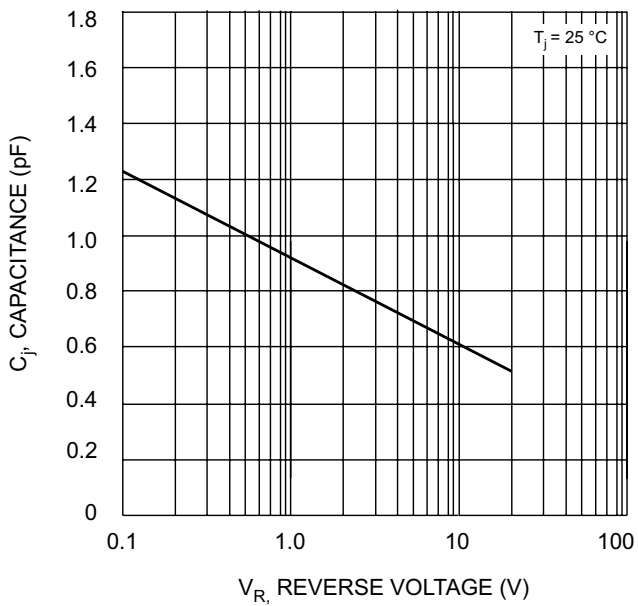
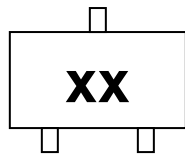

Fig. 3 Typical Junction Capacitance vs Reverse Voltage

MARKING INFORMATION



xx = Device Code, See Table Below

Mfg Site	Device Code
TW Plant	JB
CN Plant	A7

RECOMMENDED FOOTPRINT

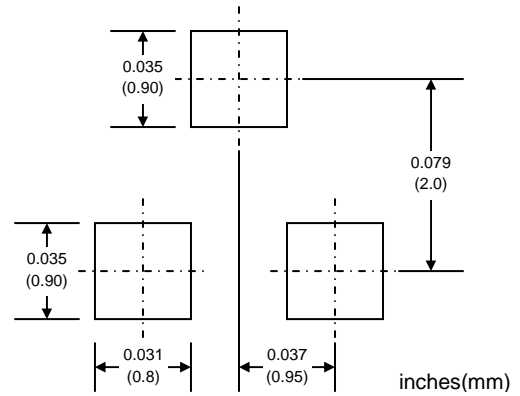

PACKAGING INFORMATION

TAPE & REEL

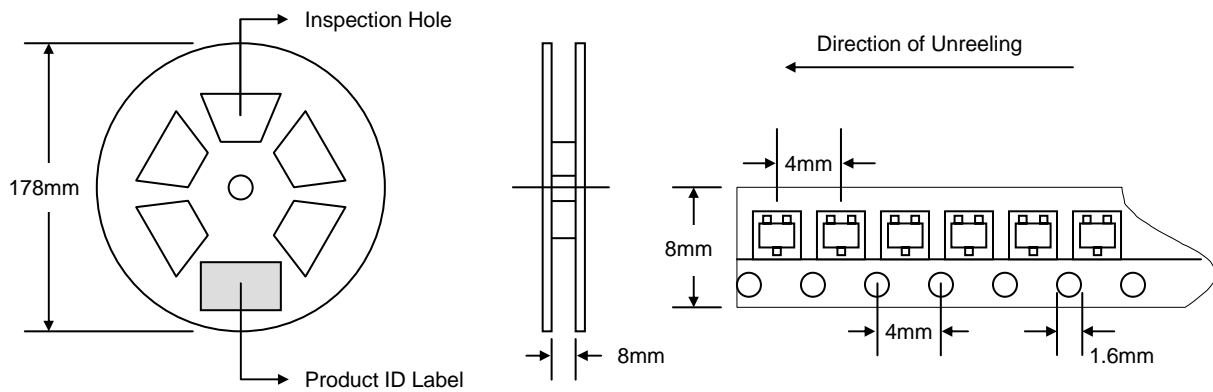

Reel Diameter (mm)	Quantity (PCS)	Inner Box Size L x W x H (mm)	Quantity (PCS)	Carton Size L x W x H (mm)	Quantity (PCS)	Approx. Gross Weight (KG)
178	3,000	187 x 187 x 65	15,000	390 x 240 x 420	150,000	10.0

Note: 1. Anti-static plastic reel, white, water clear or blue color. Inspection hole might be varied in different alignment.
2. Components are packed in accordance with EIA standard 481-1 and 481-2.

ORDERING INFORMATION

Product No.	Package Type	Shipping Quantity
BAV99-T1	SOT-23	3000/Tape & Reel

1. Shipping quantity given is for minimum packing quantity only. For minimum order quantity, please consult the Sales Department.
2. **To order RoHS / Lead Free version (with Lead Free finish), add "-LF" suffix to part number above. For example, BAV99-T1-LF.**

Won-Top Electronics Co., Ltd (WTE) has checked all information carefully and believes it to be correct and accurate. However, WTE cannot assume any responsibility for inaccuracies. Furthermore, this information does not give the purchaser of semiconductor devices any license under patent rights to manufacturer. WTE reserves the right to change any or all information herein without further notice.

WARNING: DO NOT USE IN LIFE SUPPORT EQUIPMENT. WTE power semiconductor products are not authorized for use as critical components in life support devices or systems without the express written approval.

Won-Top Electronics Co., Ltd.

No. 44 Yu Kang North 3rd Road, Chine Chen Dist., Kaohsiung, Taiwan

Phone: 886-7-822-5408 or 886-7-822-5410

Fax: 886-7-822-5417

Email: sales@wontop.com

Internet: <http://www.wontop.com>

We power your everyday.