

### Features

- Glass Passivated Die Construction
- 1500W Peak Pulse Power Dissipation
- 180V – 440V Standoff Voltage
- Uni- and Bi-Directional Versions Available
- Excellent Clamping Capability
- Fast Response Time
- Plastic Case Material has UL Flammability Classification Rating 94V-O

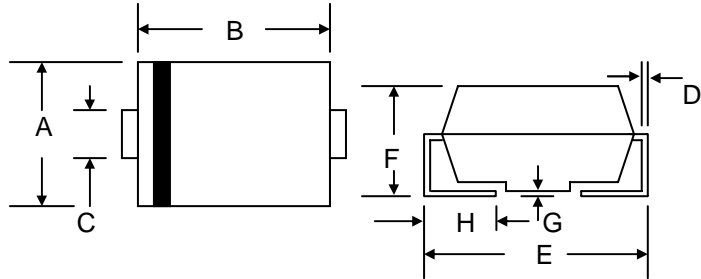

### Mechanical Data

- Case: SMC/DO-214AB, Molded Plastic
- Terminals: Solder Plated, Solderable per MIL-STD-750, Method 2026
- Polarity: Cathode Band Except Bi-Directional
- Marking: Device Code
- Weight: 0.21 grams (approx.)
- **Lead Free: For RoHS / Lead Free Version, Add “-LF” Suffix to Part Number, See Page 5**

SMC/DO-214AB		
Dim	Min	Max
A	5.59	6.22
B	6.60	7.11
C	2.75	3.25
D	0.152	0.305
E	7.75	8.13
F	2.00	2.62
G	0.051	0.203
H	0.76	1.27
All Dimensions in mm		

“C” Suffix Designates Bi-directional Devices  
 “A” Suffix Designates 5% Tolerance Devices  
 No Suffix Designates 10% Tolerance Devices

### Maximum Ratings and Electrical Characteristics @ $T_A=25^\circ\text{C}$ unless otherwise specified

Characteristic	Symbol	Value	Unit
Peak Pulse Power Dissipation 10/1000 $\mu\text{s}$ Waveform (Note 1, 2) Figure 3	PPPM	1500 Minimum	W
Peak Pulse Current on 10/1000 $\mu\text{s}$ Waveform (Note 1) Figure 4	IPPM	See Table 1	A
Steady State Power Dissipation (Note 4)	PM(AV)	6.5	W
Peak Forward Surge Current 8.3ms Single Half Sine-Wave Superimposed on Rated Load (JEDEC Method) (Note 2, 3)	IFSM	200	A
Typical Thermal Resistance, Junction to Lead (Note 5)	$R_{\theta JL}$	15	$^\circ\text{C/W}$
Typical Thermal Resistance, Junction to Ambient (Note 5)	$R_{\theta JA}$	90	$^\circ\text{C/W}$
Operating and Storage Temperature Range	$T_J, T_{STG}$	-55 to +150	$^\circ\text{C}$

- Note: 1. Non-repetitive current pulse per Figure 4 and derated above  $T_A = 25^\circ\text{C}$  per Figure 1.  
 2. Mounted on 8.0mm<sup>2</sup> copper pad to each terminal.  
 3. Measured on 8.3ms single half sine-wave or equivalent square wave, duty cycle = 4 pulses per minutes maximum.  
 4. Lead temperature at 75 $^\circ\text{C}$ .  
 5. Mounted on minimum recommended pad layout.

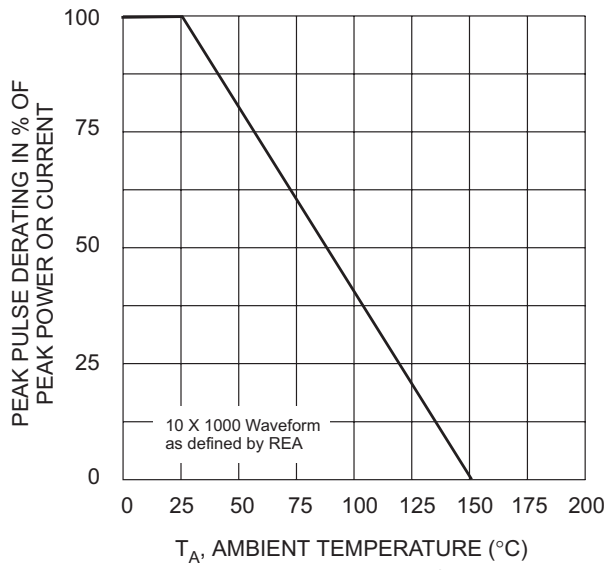

Fig. 1 Pulse Derating Curve

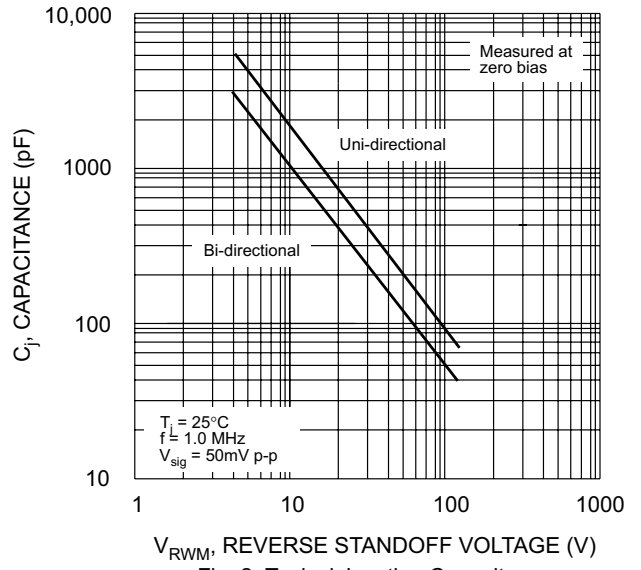

Fig. 2 Typical Junction Capacitance

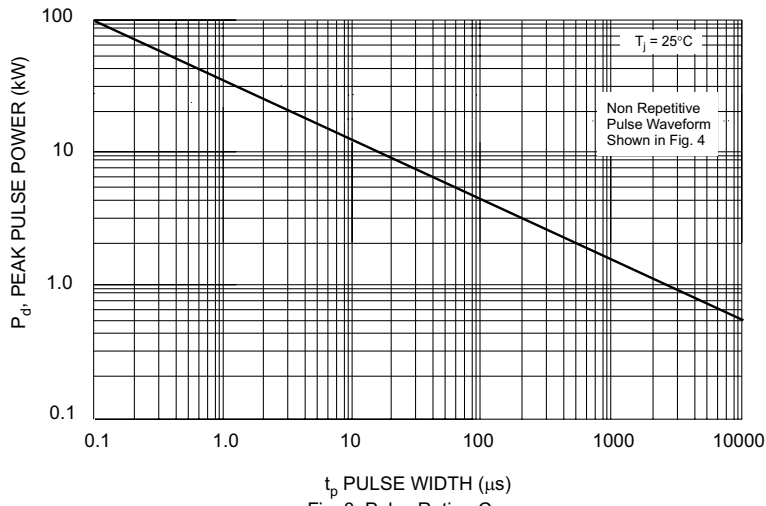

Fig. 3 Pulse Rating Curve

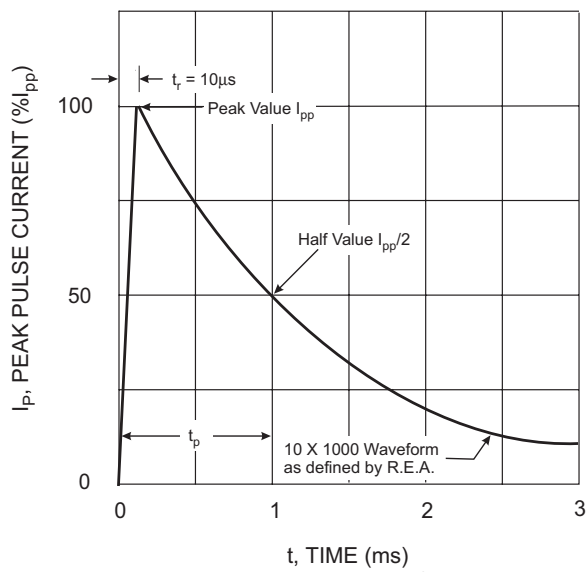

Fig. 4 Pulse Waveform

## UNI-DIRECTIONAL 1500 WATT SURFACE MOUNT TVS

UNI-DIRECTIONAL PART NO.	DEVICE MARKING CODE	REVERSE STAND-OFF VOLTAGE VRWM (V)	BREAKDOWN VOLTAGE VBR (V) MIN. @IT	BREAKDOWN VOLTAGE VBR (V) MAX. @IT	TEST CURRENT IT (mA)	MAXIMUM CLAMPING VOLTAGE @Ipp Vc (V)	PEAK PULSE CURRENT Ipp (A)	REVERSE LEAKAGE @VRWM IR (uA)
1.5SMCJ180	GHS	180.00	200.00	244.80	1	322.0	4.66	1
1.5SMCJ180A	GHT	180.00	200.00	220.00	1	292.0	5.14	1
1.5SMCJ190	GHU	190.00	211.00	258.40	1	340.0	4.41	1
1.5SMCJ190A	GHV	190.00	211.00	232.00	1	308.0	4.87	1
1.5SMCJ200A	GHX	200.00	224.00	247.00	1	324.0	4.63	1
1.5SMCJ220A	GIE	220.00	246.00	272.00	1	356.0	4.21	1
1.5SMCJ250A	GIF	250.00	279.00	309.00	1	405.0	3.70	1
1.5SMCJ300A	GIG	300.00	335.00	371.00	1	486.0	3.09	1
1.5SMCJ350A	GIH	350.00	391.00	432.00	1	567.0	2.65	1
1.5SMCJ400A	GIK	400.00	447.00	494.00	1	648.0	2.31	1
1.5SMCJ440A	GIL	440.00	492.00	543.00	1	713.0	2.10	1

## BI-DIRECTIONAL 1500 WATT SURFACE MOUNT TVS

BI-DIRECTIONAL PART NO.	DEVICE MARKING CODE	REVERSE STAND-OFF VOLTAGE VRWM (V)	BREAKDOWN VOLTAGE VBR (V) MIN. @IT	BREAKDOWN VOLTAGE VBR (V) MAX. @IT	TEST CURRENT IT (mA)	MAXIMUM CLAMPING VOLTAGE @Ipp Vc (V)	PEAK PULSE CURRENT Ipp (A)	REVERSE LEAKAGE @VRWM IR (uA)
1.5SMCJ180C	BHS	180.00	200.00	244.80	1	322.0	4.66	1
1.5SMCJ180CA	BHT	180.00	200.00	220.00	1	292.0	5.14	1
1.5SMCJ190C	BHU	190.00	211.00	258.40	1	340.0	4.41	1
1.5SMCJ190CA	BHV	190.00	211.00	232.00	1	308.0	4.87	1
1.5SMCJ200CA	BHX	200.00	224.00	247.00	1	324.0	4.63	1
1.5SMCJ220CA	BIE	220.00	246.00	272.00	1	356.0	4.21	1
1.5SMCJ250CA	BIF	250.00	279.00	309.00	1	405.0	3.70	1
1.5SMCJ300CA	BIG	300.00	335.00	371.00	1	486.0	3.09	1
1.5SMCJ350CA	BIH	350.00	391.00	432.00	1	567.0	2.65	1
1.5SMCJ400CA	BIK	400.00	447.00	494.00	1	648.0	2.31	1
1.5SMCJ440CA	BIL	440.00	492.00	543.00	1	713.0	2.10	1

## MARKING INFORMATION

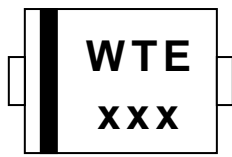

Cathode = Polarity Band Except Bi-Directional Types  
 WTE = Manufacturer's Logo  
 xxx = Device Code, See Page 3

## RECOMMENDED FOOTPRINT

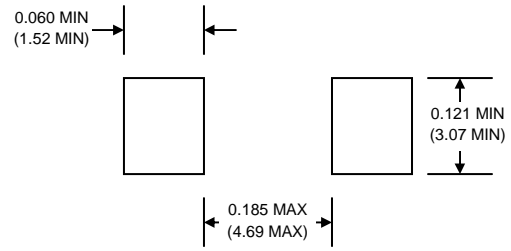

inches(mm)

## PACKAGING INFORMATION

### TAPE & REEL

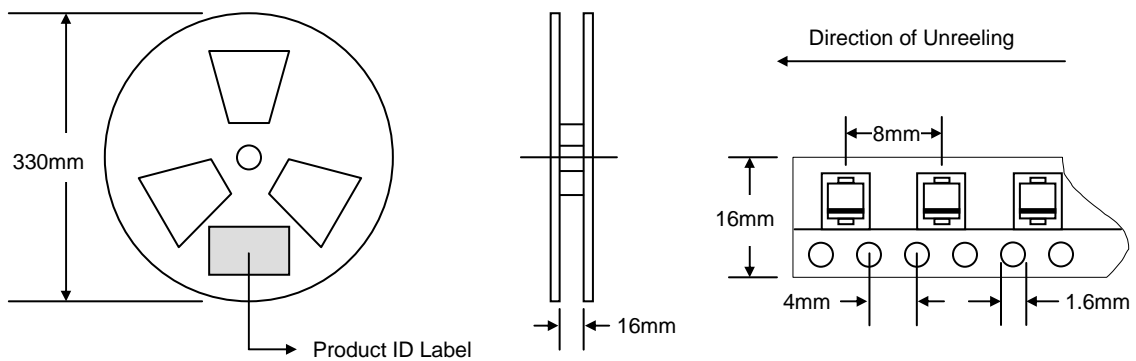

Reel Diameter (mm)	Quantity (PCS)	Inner Box Size L x W x H (mm)	Quantity (PCS)	Carton Size L x W x H (mm)	Quantity (PCS)	Approx. Gross Weight (KG)
330	3,000	340 x 337 x 45	6,000	370 x 370 x 420	48,000	19.0

**Note:** 1. Paper reel, white or gray color.  
 2. Components are packed in accordance with EIA standard 481-1 and 481-2.

## ORDERING INFORMATION

Product No.	Package Type	Shipping Quantity
1.5SMCJxx-T3	SMC	3000/Tape & Reel

1. Shipping quantity given is for minimum packing quantity only. For minimum order quantity, please consult the Sales Department.
2. **To order RoHS / Lead Free version, add “-LF” suffix to part number above. For example, 1.5SMCJ180-T3-LF.**

Won-Top Electronics Co., Ltd (WTE) has checked all information carefully and believes it to be correct and accurate. However, WTE cannot assume any responsibility for inaccuracies. Furthermore, this information does not give the purchaser of semiconductor devices any license under patent rights to manufacturer. WTE reserves the right to change any or all information herein without further notice.

**WARNING:** DO NOT USE IN LIFE SUPPORT EQUIPMENT. WTE power semiconductor products are not authorized for use as critical components in life support devices or systems without the express written approval.

**Won-Top Electronics Co., Ltd.**

No. 44 Yu Kang North 3rd Road, Chine Chen Dist., Kaohsiung, Taiwan

**Phone:** 886-7-822-5408 or 886-7-822-5410

**Fax:** 886-7-822-5417

**Email:** sales@wontop.com

**Internet:** <http://www.wontop.com>

*We power your everyday.*